

**USER MANUAL/GEBRAUCHSANLEITUNG  
MANUALE D'USO/MANUEL D'EMPLOI**

**(ENG - DEU - ITA - FRA)**

Devices / Vorrichtungen / Dispositivi / Appareils

KLICK Power Limited Edition



# KLAXON Mobility GmbH - ENG

---

Dear customer,

Thank you for choosing a KLICK product.

We sincerely hope that the KLAXON MOBILITY products can improve your day and your activities in many ways, and we remain at your disposal for any information or clarification you may require. We also encourage you to keep up to date on the latest news of our product range, on the accessories available and on our company's events and initiatives.

You can contact us by writing an email to [info@klaxon-klick.com](mailto:info@klaxon-klick.com), through our web site at [www.klaxon-klick.com](http://www.klaxon-klick.com), or on our Facebook page [www.facebook.com/klaxonklickworld](http://www.facebook.com/klaxonklickworld).

Please note also that in compliance with European regulation, KLAXON MOBILITY GMBH holds CE certification for all the products in the KLICK range; they are classified as Class I medical devices and comply with the essential safety requirements set out in Annex I to Directive 93/42/EEC, as amended by the 2007/47/EC directive.



NOTE	For visually impaired people, a pdf format of this manual is available on our website <a href="http://www.klaxon-klick.com">www.klaxon-klick.com</a> .
NOTE	You can find Klaxon Dealers address on our website <a href="http://www.klaxon-klick.com">www.klaxon-klick.com</a> in the "Where to Buy" area.

Thank you again for having chosen our products. We wish you a good day and enjoyable use.

Best regards,

**The Staff of KLAXON MOBILITY GMBH**

# KLAXON Mobility GmbH - ENG

## CONTENTS

PRELIMINARY INFORMATION	PAGE 4
1. WARNINGS	PAGE 4
2. SAFETY NOTICES	PAGE 4
3. INTENDED USE OF THE DEVICE	PAGE 5
4. USAGE ENVIRONMENT	PAGE 5
5. OPERATING LIMITS	PAGE 6
6. USER REQUIREMENTS	PAGE 6
7. WARNINGS AND PRECAUTIONS	PAGE 6
8. MARKINGS	PAGE 9
9. DESCRIPTION OF THE DEVICE	PAGE 9
9.1 PRODUCT STRUCTURE	PAGE 9
9.2 KCLICK® CONNECTION	PAGE 10
9.3 BATTERY CHARGER	PAGE 10
9.4 ACCESSORIES	PAGE 10
9.5 DOCUMENTATION	PAGE 10
10. INSTALLATION AND COUPLING	PAGE 10
10.1 INSTALLATION	PAGE 10
10.2 COUPLING STEPS	PAGE 11
10.3 WHEELCHAIR	PAGE 11
11. KCLICK POWER STANDARD LIMITED EDITION OPERATION	PAGE 11
11.1 USER INTERFACE	PAGE 11
11.2 TURNING ON AND SETTING UP THE DEVICE	PAGE 11
11.3 USE	PAGE 12
11.4 TURNING OFF AND RELEASING FROM THE WHEELCHAIR	PAGE 13
12. KCLICK POWER TETRA LIMITED EDITION OPERATION	PAGE 14
12.1 USER INTERFACE	PAGE 14
12.2 TURNING ON AND SETTING UP THE DEVICE	PAGE 14
12.3 USE	PAGE 15
12.4 TURNING OFF AND RELEASING FROM THE WHEELCHAIR	PAGE 16
13. CLEANING	PAGE 16
14. SERVICING	PAGE 16
14.1 PERIODICAL MAINTENANCE	PAGE 16
14.2 MALFUNCTIONS	PAGE 17
14.3 RACE BATTERY (11 AH)	PAGE 17
14.4 FLY RACE BATTERY (5.8 AH)	PAGE 18
15. TECHNICAL DATA	PAGE 19
15.1 CLASSIFICATION OF THE DEVICE	PAGE 19
15.2 PERFORMANCE	PAGE 19
15.3 SIZE INFORMATION	PAGE 19
15.4 ENVIRONMENTAL OPERATING CONDITIONS	PAGE 20
15.5 TRANSPORTATION AND STORAGE ENVIRONMENTAL CONDITIONS	PAGE 20

# KLAXON Mobility GmbH - ENG

15.6 TECHNICAL DESCRIPTION OF BATTERY CHARGER	PAGE 20
15.7 TECHNICAL DESCRIPTION OF BATTERIES	PAGE 20
15.8 MAIN FEATURES	PAGE 21
16. DISPOSAL OF THE DEVICE	PAGE 21
17. PRODUCT WARRANTY	PAGE 21
18. ADDENDUM	PAGE 21

## PRELIMINARY INFORMATION

### INTRODUCTION

This User's Manual explains how to use the KLICK Power Limited Edition devices that increase the independence of persons with disabilities. The KLICK product range described in this Manual includes the following models:

- Power Standard Limited Edition (**PSL**)
- Power Tetra Limited Edition (**PTL**)

### MANUFACTURER'S IDENTIFICATION DATA

#### KLAXON MOBILITY GMBH

Industriestrasse, 1  
 9601 - Arnoldstein (Austria)  
 Tel.: +43 (0)664 4681294  
 e-mail: info@klaxon-klick.com  
 Hereinafter: **KLAXON**.

### REVISION INFORMATION



REV.	Description of the change	DATE
01	Addendum to "KLICK electric series Manual - rev.6.3 of 25.05.2020"	2020-07-07

All information, illustrations and specifications in this document are based on the latest product information available at the time of publication. This document is subject to change due to technical innovations, without prior notice.

## 1. WARNINGS

- Read these instructions carefully before using the device.
- KLAXON is not liable for any failure of the end user to comply with the contents of this document.
- The use of KLICK devices is specifically dedicated to persons with disabilities who are using a manual wheelchair.
- The use of KLICK devices in public spaces (streets, sidewalks, squares, cycle paths, etc.) must comply with the specific regulations of the country in which they are used. KLAXON is not liable for use that is not in accordance with specific regulations in force.
- If any anomalies that may endanger the user are found during the usage: do not use the device and promptly contact KLAXON's technical support.
- Non-original spare parts and accessories have not been tested by the manufacturer. Therefore we cannot certify that these components are compliant with the needed performance and safety requirements.
- KLAXON is not responsible for any damage caused by the use of non-original spare parts or accessories.
- The product installation must be performed in accordance with the procedures defined by KLAXON and only by authorised personnel. Neither the safety nor the effectiveness of the device can be guaranteed if these procedures are not followed, nor can the validity of the warranty.





The points of the manual marked with the following symbols should be read carefully:

DANGER	The word DANGER indicates a potentially hazardous situation, which, if not avoided, can result in death or serious personal injury.
CAUTION	The word CAUTION indicates a potentially hazardous situation, which, if not avoided, may cause minor personal injuries or property damage.
NOTE	The word NOTE indicates important instructions or special information.
	Generic warning sign: indicates a danger due to various causes.
	High voltage warning sign: indicates the presence of high voltages.

## 2. SAFETY NOTICE

NOTE	The devices Klick Power Standard Limited Edition and Klick Power Tetra Limited Edition meet all requirements of ISO 7176-14.
------	--

# KLAXON Mobility GmbH - ENG

	The user must read this document and have become familiar with its contents before using the device.
	If the device is not used respecting the specifications described herein, the security level specified by the manufacturer may be reduced.
	During the initial period of use the user must familiarize with operation to avoid potential risks caused by incorrect use.
	EMC - The device is compliant with ISO 7176-21:2009 CLAUSE 5.4 on electromagnetic compatibility, but to ensure the user's safety we recommend not using this device in the presence of strong environmental electromagnetic fields.
	EMC - During its operation, the device can affect other devices with electromagnetic field.
DANGER	Children, incapacitated persons, or those that are insufficiently familiar with the device or physically unsuited, must not use it.
NOTE	For technical and safety info you can contact a Klaxon Dealer.

- The device may skid on wet pavement, on gravel or on uneven terrain: always adjust speed and driving style to the conditions (weather, surface, individual capacity, etc.); never drive straight towards an object, and drive carefully towards narrow passages.
- Do not attempt to go over steps higher than 50 mm, both uphill and downhill, along the direction travelled. Do not drive the KLICK-equipped wheelchair on roads with rated slopes that exceed 6°/ 10%. These obstacles must always be overcome frontally and slowly. The proper way to go over steps and to go up slopes is shown in Figure 1.
- If the pavement is wet or uneven, the maximum rated slope and the maximum height of the steps allowed must be considered lower to ensure the user's safety.
- In the event of a collision, the user could suffer serious injury to body parts.
- At high speed the user may lose control of the wheelchair and it may tip over. Never exceed 15 km/h, and avoid impacts in general.
- Always use the KLICK-equipped wheelchair suitably. Always brake in order to avoid obstacles (steps, edges, door frames, etc.), during descents, curves and/or dangerous slopes.
- Driving performance of the KLICK-equipped wheelchair may be affected by electromagnetic fields. If a malfunction occurs in these conditions please contact KLAXON or one of its authorised resellers.
- Avoid contact with any liquid coming out of the battery if it is damaged.
- While using the device, some system components can get very hot. A contact of these components with the skin may cause scalding and burns: be extremely careful to avoid contact.
- Always observe the operating limits for the manual wheelchair on which the KLICK system is installed.

### 3. INTENDED USE OF THE DEVICE

KLICK devices can be used to add an auxiliary power assist system to most manual wheelchairs, quickly and easily.

Coupling the KLICK device to the wheelchair raises the front castors off the ground. The single wheel of the "traction unit" is then used for steering.

KLICK devices are classified for use with wheelchairs to which they are coupled pursuant to CEI EN 12184. KLICK devices are also compliant with the requirements of class B with maximum range of about 50 km (for the version with a charged 11 Ah battery, on a flat course and 75 kg user).

In accordance with the definition of class B of CEI EN 12184, the device is for indoor use and can handle outdoor obstacles.

	Any other use or misuse could result in hazardous situations.
---	---

### 4. USAGE ENVIRONMENT

#### Operating Environment

KLICK series devices are made for use coupled to most manual wheelchairs on the market. KLICK solutions can be used both indoors and outdoors, with the limits stated in this document, and in general with the same limitations set for the use of the manual wheelchair.

#### Medical use and types of users

KLICK is not intended for specific clinical use, but as a support to the mobility of persons who use manual wheelchairs. Therefore, bearing in mind the operating precautions described in this document, there is no need for professional, technical or aptitude requirements to operate or use a KLICK device.

## 5. OPERATING LIMITS

The device must be used consistently with the intended use described in the preceding paragraphs, any other use is considered as improper.

In particular do not use KLICK devices:













- If not coupled with a manual wheelchair.
- After intake of alcohol or if the user's psycho-physical conditions are unsuitable.
- On roads with unsuitable pavement.
- In poor visibility (at night, in fog, etc.).
- If the user weighs over 120 kg or is heavier than allowed for the wheelchair used.
- In adverse weather (rain, strong wind, etc.).
- When going uphill or downhill on rated slopes that are exceeding 6° / 10%. (see Figure 2).
- To go over steps higher than 50 mm, both uphill and downhill. (see Figure 3).

## 6. USER REQUIREMENTS









KLICK series devices and its accessories can be used independently by users that:





- That are familiar and have practised proper use of the device sufficiently.
- That are aware of the risks related to the use of the device.
- That have sufficient physical and mental capacity to ensure the appropriate safe use of the device.







## 7. WARNINGS AND PRECAUTIONS

	This User's Manual is an integral part of the device and must always be available to the user. If it is lost or damaged, contact KLAXON.
	KLICK series devices and accessories can be used by users who are aware of the risks associated with the use thereof.
	KLICK series devices and accessories must be used only and exclusively by users that are familiar and have practised proper use of the device sufficiently.
	Absolutely never remove, modify or replace components of the device. If necessary, these operations must be carried out only by technical personnel authorised to do so by KLAXON.
	Never use the device after having drunk alcohol, taken drugs and in general if the user's psycho-physical conditions are unsuitable.
	The use of KLICK devices is prohibited for users weighing more than 120 kg; the total weight of the user must not exceed the quantity specified by the manufacturer of the wheelchair in use.
	The user is responsible for monitoring and maintaining proper operation of the devices and of their accessories as indicated herein.
	Absolutely never use the device outside of the stated environmental operating conditions.
	Periodic maintenance must be performed to ensure proper operation and the safety of the device.
	Do not use a KLICK device to carry more than one person.
	Do not use a KLICK device unless it is coupled with a manual wheelchair.
	Do not use the supplied battery pack to power systems other than the KLICK device for which it was designed.

# KLAXON Mobility GmbH - ENG



















	Do not leave the battery in the sun or adverse weather when not in use.
	Do not short-circuit the battery.
	Do not throw the battery in water.
	Do not attempt to open the battery pack.
DANGER	Do not allow children to play with the battery.
	Do not allow children to use the KLICK device.
	If the battery has reached its end of life, it must be disposed of in the special containers at designated collection centres.
	While using the device, some system components can get very hot and contact of these components with the skin may cause scalding and burns: be extremely careful to avoid contact.
	The components can become very hot if exposed to the sunlight. Skin contact may cause scalding and burns: be extremely careful to avoid contact.

	DANGER: The voltages inside the device can be lethal.
	DANGER: Do not connect/disconnect power cables when the device is on.
	DANGER: Maintenance or cleaning the device must always be carried out when the device is off and disconnected from the mains.
	DANGER: Do not remove any of the unit's cover panel, contact the Technical Support Service.

	The use of KLICK devices in public spaces (streets, sidewalks, squares, cycle paths, etc.) must comply with the specific regulations of the country in which they are used. KLAXON is not liable for use that is not in accordance with specific regulations in force.
	Adjust speed in relation to the characteristics of the wheelchair, the road conditions, the lateral inclination of the road and the radius of the curves to take.
	Do not operate the device in poor lighting conditions. The device is not suitable for use at night.
	Pay attention to side-skidding due to strong wind.
	Pay attention to side-skidding due to steering while moving.
	Pay attention to side-skidding due to the slope of the road.



## KLAXON Mobility GmbH - ENG











	Do not use KLICK devices on roads with unsuitable pavement.
	Do not use KLICK devices with adverse weather (rain, strong wind, etc.).
	Do not use the KLICK devices to go up or down steps higher than 50 mm (see Figure 3).
	Do not use KLICK devices on rated slopes greater than 6°/10% . The value can also be lower in accordance with the pavement condition (see Figure 2).
	Consider that traction and stability might be affected by the pavement condition even within maximum slope.
	When driving downhill, do not exceed two-thirds of the maximum speed; avoid sudden braking or accelerations on slopes.
	Never go over obstacles when driving uphill or downhill.
	Do not go up or down staircases.
	Do not attempt to go over obstacles diagonally: make sure that the rear wheels always go over the obstacle together. Never stop halfway. Do not attempt to go over obstacles over 50 mm high.
	When the device is in motion, avoid moving the centre of gravity or abruptly moving your body.
	It is advisable to drive through narrow passages at minimum speed and with utmost caution.
	When using KLICK devices, the risk of tipping-over during cornering increases: reduce speed before turning. Accelerate again only after completing the curve.
	When using KLICK devices, do not make U-turns on rated slopes greater than 3° (or lower according to pavement condition) and at a speed higher than level 1 and 3km/h (or lower according to pavement condition).
	It can be difficult to manoeuvre in front of a lift or at the entrance of a building since the wheelchair's turning radius increases when coupled with a KLICK device; this could conflict with the standards of the buildings or the actual size of the entrances.
	When entering a building and/or an elevator, always take into account the turning radius of your wheelchair equipped with the KLICK device. Avoid driving into situations from which you would not be capable of exiting because you would be unable to turn your wheelchair.
	Absolutely never use the Klick device along tramway, rail and light railway tracks. Pay the utmost attention at level crossings, keeping the Klick's and wheelchair wheels at due distance. Failure to comply with this precaution could cause serious damages to the device and the user. The same precautions apply to water drains, manholes and all kinds of hollows along the way.
DANGER	Consider that the stopping distance on slopes can be significantly greater than on a flat ground.
	Switch off the device before entering and before leaving an indoor ambient.
	Potential finger traps are shown in Figure 49. Potential squeezing points are shown in Figures 50 and 51.

# KLAXON Mobility GmbH - ENG

DANGER	Do not start or use the cruise control function on rated slopes greater than 6° (or lower according to pavement condition).
CAUTION	Handling points for carry the device are shown in Figure 48.

## 8. MARKINGS

The device is uniquely identified by its serial number (SN), shown on the plate of the device, attached to the motor unit near the battery. The meaning of the symbols shown in the plate are as follows:

Symbol	Description
	Manufacturer
	Reference number
	Serial number
	Year of manufacture
	Symbol indicating: Follow the instructions for use
	Symbol indicating that the wheelchair (device) is not intended to be used as a seat in a motor vehicle
	Maximum User Weight
	CE mark
	Electrical device disposal via separated collection (special disposal, electrical components)
	Maximum Speed of the Device
	Maximum inclination of the slope you can drive with the Device

Pictures of an example of the CE Label, applied on every Klick devices.

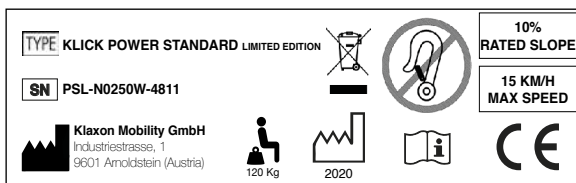

## 9. DESCRIPTION OF THE DEVICE

### 9.1 PRODUCT STRUCTURE

#### A. KLIK POWER STANDARD LIMITED EDITION

Figure 4 shows the KLIK POWER STANDARD LIMITED EDITION device and identifies the elements that make it up.

1. Steering wheel and Motor unit
2. Brake system
3. Kickstand

4. Standard Handlebar
5. Battery
6. Standard Connector

## B. KLIICK POWER TETRA LIMITED EDITION

Figure 5 shows the KLIICK POWER TETRA LIMITED EDITION device and identifies the elements that make it up.

1. Steering wheel and Motor unit
2. Brake system
3. Kickstand
4. Tetra Handlebar "Push & Pull" (with acceleration and braking functions)
5. Battery
6. Tetra Connector

## 9.2 KLIICK® CONNECTION

See Figure 6.

### A. CLAMPING RINGS

The clamping rings are the parts of the KLIICK connection that always remain attached to the wheelchair frame (see Figure 7). Together with the crossbeam, they must be installed on the wheelchair by authorised KLAXON personnel and must never be removed by the user during use. Various clamping ring sizes and shapes are available to suit the different tubing diameters and types of wheelchair frames.

### B. CROSSBEAM

Figure 8 illustrates a CROSSBEAM and identifies the elements that make it up.

1. CROSSBEAM
2. Square seats for insertion of the CONNECTOR
3. Locking pins
4. Fixing clamp

### C. CONNECTOR (WITH DETAIL OF PATENTED "KLAXON® SYSTEM")

Figure 9 illustrates a STANDARD CONNECTOR and identifies the elements that make it up.

1. CONNECTOR lock/unlock lever
2. Mounting system in the CROSSBEAM (with ball-type lock)
3. KLIICK device release button
4. KLIICK® coupling (Worldwide Patented)
5. Seat of upper pin
6. Seat of lower pin.

### D. TETRA CONNECTOR (WITH DETAIL OF PATENTED "KLAXON® SYSTEM")

Figure 10 illustrates a TETRA CONNECTOR and identifies the elements that make it up.

1. Velcro grip of CONNECTOR
2. Mounting system in the CROSSBEAM (with ball-type lock)
3. Easy release lever of the KLIICK device
4. KLIICK® coupling (Worldwide Patented)
5. Seat of upper pin
6. Seat of lower pin

## 9.3 BATTERY CHARGER

Figure 11 shows the battery charger that is supplied with the RACE (11 Ah) and FLY RACE (5,8 Ah) batteries, which are compatible with KLIICK Power Standard Limited Edition and KLIICK Power Tetra Limited Edition devices.

## 9.4 ACCESSORIES

KLIICK can be equipped with various accessories. You may need to consult the appropriate User's Manual (ask KLAXON or visit our website: [www.klaxon-klick.com](http://www.klaxon-klick.com)) for some of them.

## 9.5 DOCUMENTATION

This USER'S MANUAL is provided with the Device in printed format and must be stored with the utmost care. If you lose the above documents, request a copy of them in writing to KLAXON.

## 10. INSTALLATION AND COUPLING

### 10.1 INSTALLATION

KLIICK devices are provided by KLAXON (or by an authorised technician) only after having pre-installed the coupling set on the wheelchair.

## 10.2 COUPLING STEPS

	During the entire coupling operation, stop in a flat area, as free as possible from uneven ground and away from hazards which could cause personal injury.
<b>DANGER</b>	Be careful not to squeeze or trap your fingers during the coupling operation. Potential finger traps are shown in Figure 49. Potential squeezing points are shown in Figures 50 and 51.

- Insert the CROSSBEAM in one of the two CLAMPING RINGS and secure it by inserting the specific LOCKING PIN (Figure 12).
- Insert the CROSSBEAM also in the second CLAMPING RING and secure it by inserting the specific LOCKING PIN (Figure 13).  
Note: The CROSSBEAM can always remain installed on the wheelchair; if necessary (for loading and unloading from vehicles and closing the folding wheelchair) it can be removed and placed in a safe place.
- Insert the CONNECTOR in the square seat of the CROSSBEAM, pressing the lever located on its bottom. Once inserted, release the lever and make sure that the CONNECTOR is securely locked (Figure 14).
- After having inserted the CONNECTOR, the device will be as shown (Figure 15).
- To secure the KLICK device to the connection, move the wheelchair into position as shown (Figures 16 and 17). Make sure the opening of the coupling is placed over the upper pin (Figure 18).
- Holding it in place, brake the wheelchair with its brakes and grip the handlebar; lift KLICK until the upper pin is fully inserted in the opening of the coupling (Figure 19).
- At this point, continue to raise the handlebar by pushing it forward until the lower pin is fully engaged with the connection; at that point the safety button is triggered (Figure 20).

### CAUTION!

Once the device is connected to the wheelchair, it is important to ensure that:

- The ground clearance of the front wheels of the wheelchair should be between 25mm and 40 mm (with the wheelchair empty - Figure 21).
- The kickstand is located above the line of the front wheels and placed below the footrest (Figure 22).

<b>CAUTION</b>	If these requirements are not met, never use the device for any reason and immediately contact an authorised KLAXON service centre.
----------------	---

## 10.3 WHEELCHAIR

	KLICK devices can be installed only on compatible wheelchairs. KLAXON provides to the distributors the Installation Manual which contains the coupling criteria. KLICK products must be installed only by authorised KLAXON technicians who may decide, under their own responsibility, if the specific wheelchair can be properly used with the KLICK device (according to both wheelchair features and general condition).
---	--

## 11. KLICK POWER STANDARD LIMITED EDITION OPERATION

### 11.1 USER INTERFACE

The device is equipped with a multifunction LCD display, used to switch the device on and off, select the maximum speed and display several operating parameters (Figure 23).

- The icon located top left (1) shows the current battery charge level.
- The number (2) in the centre of the display shows the speed, in km/h.
- The number (3) in the lower part of the display shows the distance travelled, in km.
- The number (4) shows the desired maximum speed level.

### 11.2 TURNING ON AND SETTING UP THE DEVICE (FIGURE 23).

#### A. Turning On and Selecting the Speed

- Switch on the battery (for more information please refer to the instructions starting from section 14.3).
- Press and hold the **"POWER"** button for 5 seconds, until the display turns on.
- Press the **"UP ARROW"** and **"DOWN ARROW"** buttons to select the desired maximum speed level (viewable in the left panel of the display, number (5) in the legend); various speed levels can be selected, between 0 (motor disabled), 1 (minimum speed, 3 km/h), 2 (normal speed, 6 km/h), 3 (medium speed, 10 km/h), 4 (high speed, 13 km/h) and 5 (maximum speed, 15 km/h).

#### B. Navigating the data

- After turning on the display, the initial screen shows (in number 3) the total distance (ODO) the device has been used.
- Press the **"POWER"** button once to enter the second screen. It will show the partial distance (TRIP - number 3).

- Pressing the **"POWER"** button again for two times will display the time the device has been on, in minutes (TIME – number 3).
- Pressing the **"POWER"** button again for three times will display the maximum speed (ODO MAX – number 2); pressing the **"POWER"** button again will display in the same screen the average speed (ODO AVG).
- To reset trip data, hold down the **"UP ARROW"** and **"DOWN ARROW"** buttons together for 5 seconds.

## C. Screen Backlighting

- Hold the **"UP ARROW"** button for 5 seconds to turn on the screen backlight.
- To turn off the backlight, press the **"UP ARROW"** button for 5 seconds again.
- When the device is turned off, the light is also automatically switched off.

## D. "Walking Pace" Function

- Press the **"DOWN ARROW"** button for 5 seconds to turn on the speed hold function. This function accelerates the device up to a speed of 4,5 km/h and holds it as long as the button is pressed.
- When the button is released, the device instantly stops accelerating.

## E. Cruise Control function

- The Cruise Control function is adaptive and allows to keep the speed fixed while riding even uphill and downhill.
- To activate this function the speed has to be higher than 3 km/h.
- Press the dedicated green button (Figure 54) to insert the Cruise Control function, which will run the KLICK at the actual speed; the display at number (3) will show the letter "C" as long as the function is activated.
- The Cruise Control function must be deactivated by one of the following modes: operating on the Brake lever (left or right), operating on the Accelerator control, by pressing the EBS button, by pressing again the green dedicated button.

ATTENTION: By activating the Reverse switch the Cruise Control function will be NOT switched off.

## F. "Comfort" and "Sport" mapping

- To activate the "Comfort " Mapping move the red dedicated switch to **"O"** (Figure 52). The KLICK will now accelerate smoothly and gradually. This option is suggested for the normal usage of the device.
- To activate the "Sport " Mapping move the red dedicated switch to **"I"** (Figure 53) . The KLICK will now accelerate faster. This option is suggested for all the situation in which a prompt acceleration is needed.

## G. Electronic Brake System (EBS)

- This function stops the Klick device by reducing its speed to 0 km/h. During the EBS braking the energy produced will be recovered and used to recharge the battery (Figure 41).
- Squeezing the first part of the brake lever will activate the EBS. This action will combine with the mechanical braking if the brake lever is pressed harder. The EBS can also be activated by pushing the dedicated red button (Figure 26.1).

DANGER	When using the Cruise Control function it is mandatory to pay the utmost attention to road hazards in order to be able to intervene promptly on the controls so as to avoid any type of collision that may cause damage to persons and/or property.
DANGER	Every action and/or tampering of the display to change performance and KLICK's security is strictly prohibited. The sole and only actions possible are those specified in paragraph 11.2 of this User's Manual.
CAUTION	By activating the Reverse switch, the Cruise Control function will be NOT switched off.
CAUTION	Although the cruise control is adaptive, there may be slight differences between the set speed and the actual speed when descending a slope. As a precaution it is recommended to set a lower speed when driving downhill.
DANGER	Do not start or use the cruise control function on rated downhill slopes greater than 3°/5%. Do not start or use the cruise control function on rated uphill slopes greater than 6°/10%.
	Pay attention when using cruise control in critical situations (curves, obstacles, slopes and so on): the device will not reduce the speed automatically.

NOTE: For further information on the display, see [www.klaxon-klick.com](http://www.klaxon-klick.com) or contact an authorised KLAXON dealer.

## 11.3 USE

Figure 24 shows the Standard handlebar of the Klick device and it identifies the elements that make it up (listed below).

1. Handlebar

2. Accelerator control
3. Multi-function control panel (Figure 25) with "Comfort" and "Sport" mapping switch (1), Cruise Control button (2) and Reverse Gear switch (3).
4. Display
5. Brake levers
6. EBS Button

Once the device has been installed, the display has been turned on and a speed has been selected, use the accelerator control to make the device start to move (Figure 26.1). To stop the device, use the brake lever or press the **"EBS BUTTON"** (the red button in Figure 26.1). The KLICK brake is equipped with an additional safety device that deactivates the motor and activates the EBS when the lever is operated (Figure 26.2).

The device is equipped with a reverse gear as standard equipment. To use the reverse, move the switch to the right until it is located under the **"RIGHT ARROW SYMBOL"** (Figure 27), then press the accelerator to start moving backward.

To return to the forward gear, release the accelerator and move to the left the switch until it is located in the center or under the **"LEFT ARROW SYMBOL"** (Figure 28).

CAUTION	The reverse button has only luminous warning systems to show whether it is selected or not. This can occur in two ways: VISUAL-> when the switch is located in the center or under the <b>"LEFT ARROW SYMBOL"</b> the reverse gear is DISENGAGED; when the switch is located under the <b>"RIGHT ARROW SYMBOL"</b> the reverse gear is ENGAGED. LUMINOUS > when the reverse gear is ENGAGED, the display flashes off and on repeatedly the backlight. When the reverse gear is DISENGAGED this function stops responding.
CAUTION	After inserting the battery in its housing and locked by turning the key, remove it and put it in a safe place. It is absolutely forbidden to use the KLICK device with the key inserted in the security block.

The accelerator control, the EBS button, the multi-function control panel and the display can be installed either on the left or on the right side of the handlebar according to the user's preference.

DANGER	For the installation and positioning of controls (display, accelerator control, multi-function control panel, EBS button), contact an authorised KLAXON service centre.
DANGER	Before using the reverse gear to move the device, make sure that there are no persons, obstacles, stairs, slopes behind the wheelchair.
DANGER	At each restart pay maximum attention, before accelerating, to check if the forward or reverse gear is currently selected, especially when close to obstacles, drop-offs and any other kind of danger.
DANGER	If obstacles, drop-offs and dangers are too close to be safe, turn off the KLICK device and manually move the wheelchair to a safe place.
CAUTION	Always apply the correct force to the brakes. Squeezing too hard the lever may cause the front wheel blockage. This will increase the braking distance and compromise the overall stability.

#### 11.4 TURNING OFF AND RELEASING FROM THE WHEELCHAIR

To perform the operation properly, carefully follow the following instructions.

- Stop the wheelchair on a flat surface.
- Apply the brake on the wheelchair.
- Turn off the display by pressing and holding the **"POWER"** button for 5 seconds.
- Push the handlebar forward with one hand grasping it in the middle and simultaneously press the release button on the CONNECTOR with the other hand. This frees the lower pin of the KLICK coupling (Figure 29).
- Reduce forward pressure on the handlebar while holding the release button on the CONNECTOR, thus lowering the wheelchair so that its front wheels make contact with the pavement (Figure 30).
- At this point the upper pin will already be pulled out the front hook of the CONNECTOR; release the wheelchair's brakes and push yourself back to move away from the KLICK device (which in the meantime will remain upright thanks to its KICKSTAND - Figure 31).
- Remove the CONNECTOR, pulling the lever located on its bottom (Figure 14).

DANGER	During the KLICK release operation, pay attention to not endanger the top parts of your body (fingers, hands, arms) as they could be affected by the sudden movement of the handlebar (or other parts of the device) if it is released too quickly. To avoid this danger, after pressing the release button, gently release the handlebar by lowering the wheelchair gradually.
--------	---

## 12. KLICK POWER TETRA LIMITED EDITION OPERATION

### 12.1 USER INTERFACE

The device is equipped with a multifunction LCD display, used to switch the device on and off, select the maximum speed and display several operating parameters (Figure 23).

- The icon located top left (1) shows the current battery charge level.
- The number (2) in the centre of the display shows the speed, in km/h.
- The number (3) in the lower part of the display shows the distance travelled, in km.
- The number (4) shows the desired maximum speed level.

### 12.2 TURNING ON AND SETTING UP THE DEVICE (FIGURE 23).

#### A. Turning On and Selecting the Speed

- Switch on the battery (for more information please refer to the instructions starting from section 14.3).
- Press and hold the **"POWER"** button for 5 seconds, until the display turns on.
- Press the **"UP ARROW"** and **"DOWN ARROW"** buttons to select the desired maximum speed level (viewable in the left panel of the display, number (5) in the legend); various speed levels can be selected, between 0 (motor disabled), 1 (minimum speed, 3 km/h), 2 (normal speed, 6 km/h), 3 (medium speed, 10 km/h), 4 (high speed, 13 km/h) and 5 (maximum speed, 15 km/h).

#### B. Navigating the data

- After turning on the display, the initial screen shows (in number 3) the total distance (ODO) the device has been used.
- Press the **"POWER"** button once to enter the second screen. It will show the partial distance (TRIP - number 3).
- Pressing the **"POWER"** button again for two times will display the time the device has been on, in minutes (TIME - number 3).
- Pressing the **"POWER"** button again for three times will display the maximum speed (ODO MAX - number 2); pressing the **"POWER"** button again will display in the same screen the average speed (ODO AVG).
- To reset trip data, hold down the **"UP ARROW"** and **"DOWN ARROW"** buttons together for 5 seconds.

#### C. Screen Backlighting

- Hold the **"UP ARROW"** button for 5 seconds to turn on the screen backlight.
- To turn off the backlight, press the **"UP ARROW"** button for 5 seconds again.
- When the device is turned off, the light is also automatically switched off.

#### D. "Walking Pace" Function

- Press the **"DOWN ARROW"** button for 5 seconds to turn on the speed hold function. This function accelerates the device up to a speed of 4.5 km/h and holds it as long as the button is pressed.
- When the button is released, the device instantly stops accelerating.

#### E. Cruise Control function

- The Cruise Control function is adaptive and allows to keep the speed fixed even when riding uphill or downhill.
- To activate this function the speed has to be higher than 3 km/h.
- Press the the dedicated green button (Figure 54) to insert the Cruise Control function, which will run the KLICK at the actual speed; the display at number (3) will show the letter "C" as long as the function is activated.
- The Cruise Control function must be deactivated by one of the following modes: by pushing the Tetra Handlebar forward to brake, by pulling the Tetra Handlebar towards you to accelerate, by pressing the EBS button, by pressing again the green dedicated button.

ATTENTION: By activating the Reverse switch the Cruise Control function will be NOT switched off.

#### F. "Comfort" and "Sport" mapping

- To activate the "Comfort" Mapping move the red dedicated switch to **"O"** (Figure 52). The KLICK will now accelerate smoothly and gradually. This option is suggested for the normal usage of the device.
- To activate the "Sport" Mapping move the red dedicated switch to **"I"** (Figure 53). The KLICK will now accelerate faster. This option is suggested for all the situation in which a prompt acceleration is needed.

#### G. Electronic Brake System (EBS)

- This function stops the Klick device by reducing its speed to 0 km/h. During the EBS braking the energy produced will be recovered and used to recharge the battery (Figure 41).
- Pushing the first part of the Tetra handlebar forward activates the EBS. This action will combine with the mechanical braking if the handlebar is pushed further on. The EBS can also be activated by pushing the dedicated red button.

DANGER	When using the Cruise Control function it is mandatory to pay the utmost attention to road hazards in order to be able to intervene promptly on the controls so as to avoid any type of collision that may cause damage to persons and/or property.
--------	---

# KLAXON Mobility GmbH - ENG

DANGER	Every action and/or tampering of the display to change performance and KLICK's security is strictly prohibited. The sole and only actions possible are those specified in paragraph 12.2 of this User's Manual.
CAUTION	By activating the Reverse switch, the Cruise Control function will be NOT switched off.
CAUTION	Although the cruise control is adaptive, there may be slight differences between the set speed and the actual speed when descending a slope. As a precaution it is recommended to set a lower speed when driving downhill.
DANGER	Do not start or use the cruise control function on rated downhill slopes greater than 3°/5%. Do not start or use the cruise control function on rated uphill slopes greater than 6°/10%.
	Pay attention when using cruise control in critical situations (curves, obstacles, slopes and so on): the device will not reduce the speed automatically.

NOTE: For further information on the display, see [www.klaxon-klick.com](http://www.klaxon-klick.com) or contact an authorised KLAXON dealer.

## 12.3 USE

Figure 32 shows the Tetra handlebar of the Klick device and it identifies the elements that make it up (listed below).

1. Handlebar
2. Multi-function control panel (Figure 25) with "Comfort" and "Sport" mapping switch (1), Cruise Control button (2) and Reverse Gear switch (3).
3. Display
4. EBS Button

Once the device has been installed, the display has been turned on and a speed has been selected, use the handlebar (pulling it toward you) to make the device start to move (Figure 33). To stop the device, activate the brake system by pushing the handlebar forward (Figure 34) or press the **"EBS BUTTON"** (the red button in Figure 32). The KLICK brake is equipped with an additional safety device which deactivates the motor and activates the EBS when the handlebar is pushed forward (Figure 34).

The device is equipped with a reverse gear as standard equipment. To use the reverse, move the switch to the right until it is located under the **"RIGHT ARROW SYMBOL"**, then pull the Tetra Handlebar towards you to start moving backward (Figure 33)

To return to the forward gear, release the handlebar and move to the left the button until it is located in the center or under the **"LEFT ARROW SYMBOL"** (Figure 33).

CAUTION	The reverse button has only luminous warning systems to show whether it is selected or not. This can occur in two ways: VISUAL-> when the switch is located in the center or under the <b>"LEFT ARROW SYMBOL"</b> the reverse gear is DISENGAGED; when the switch is located under the <b>"RIGHT ARROW SYMBOL"</b> the reverse gear is ENGAGED. LUMINOUS > when the reverse gear is ENGAGED, the display flashes off and on repeatedly the backlight. When the reverse gear is DISENGAGED this function stops responding.
CAUTION	After inserting the battery in its housing and locked by turning the key, remove it and put it in a safe place. It is absolutely forbidden to use the KLICK device with the key inserted in the security block.

The EBS button, the multi-function control panel and the display can be installed either on the left or on the right side of the handlebar according to the user's preference.

DANGER	For the installation and positioning of controls (display, multi-function control panel, EBS button), contact an authorised KLAXON service centre.
DANGER	Before using the reverse gear to move the device, make sure that there are no persons, obstacles, stairs, slopes behind the wheelchair.
DANGER	At each restart pay maximum attention, before accelerating, to check if the forward or reverse gear is currently selected, especially when close to obstacles, drop-offs and any other kind of danger.
DANGER	If obstacles, drop-offs and dangers are too close to be safe, turn off the KLICK device and manually move the wheelchair to a safe place.



<b>CAUTION</b>	Always apply the correct force to the brakes. Pressing too suddenly and too forcefully the Tetra handlebar may cause the front wheel blockage. This will increase the braking distance and compromise the overall stability.
----------------	--

## 12.4 TURNING OFF AND RELEASING FROM THE WHEELCHAIR

To perform the operation properly, carefully follow the following instructions.

- Stop the wheelchair on a flat surface.
- Apply the brake on the wheelchair.
- Turn off the display by pressing and holding the **"POWER"** button for 5 seconds.
- Firmly push the quick release lever of the CONNECTOR TETRA sideways to the right. By doing so, the lower pin is automatically released and the KLICK disengages from the CONNECTOR, lowering the wheelchair and bringing the front wheels in contact with the ground (Figures 35 and 36).
- At this point the upper pin will already be pulled out the front hook of the CONNECTOR; release the wheelchair's brakes and push yourself back to move away from the KLICK device (which in the meantime will remain upright thanks to its KICKSTAND - Figure 37).
- Remove the CONNECTOR, pulling the Velcro grip upward and forward (Figure 38).

<b>DANGER</b>	During the KLICK release operation, pay attention to not endanger the top parts of your body (fingers, hands, arms) as they could be affected by the sudden movement of the handlebar (or other parts of the device) if it is released too quickly. To avoid this danger, after pressing the release button, gently release the handlebar by lowering the wheelchair gradually.
---------------	---

## 13. CLEANING

Regularly cleaning the entire device makes it last longer and work better.

We recommend:



- To switch the device off and to disconnect the battery charger before cleaning it.
- To not use abrasive cleaning agents, detergents and high pressure cleaners.
- To clean the device with a soft, damp cloth.
- To dry the unit thoroughly after using it out in the rain.
- In case the device is dirty, to soften the dirt and to remove it as soon as possible; then dry the device carefully.
- To clean all the outside of the device at least once a month and after each ride on muddy terrains.
- To be careful not to wet the electrical parts (battery, display, motor).
- To not wash the parts under running water
- To dry the parts immediately after washing by using a soft cloth.
- If the electrical parts get wet, let them dry and do not use the device until they are completely dry.

## 14. SERVICING

KLICK devices must be serviced regularly, to ensure safe, reliable and efficient operation.

KLAXON is not responsible for any damage caused by non-maintenance or by insufficient maintenance. In such cases the warranty may be voided.

Unscheduled maintenance can be carried out only by technicians authorised by KLAXON's Technical Support Service.

	Klick devices must be serviced/maintained only by KLAXON's Dealer.
	Do not remove any component from the device. Only Klaxon dealers can remove components from Klick devices. The only component that can be removed by the user is the battery.
<b>NOTE</b>	Please contact a Klaxon Dealer to know whether a spare part is available or not.

## 14.1 PERIODICAL MAINTENANCE

We recommend the following regular maintenance:

- At least once a month, check the tyre inflation pressure; a flat tyre affects the vehicle's smooth ride, its safety and its power consumption. The tyre of a Klick devices must be inflated to 2.7 bar.

<b>CAUTION</b>	Be careful when using high pressure air to inflate the tyre.
----------------	--

# KLAXON Mobility GmbH - ENG

- At least once a month, check the tyres wearing. To replace an inner tube or a tyre, contact an authorised KLAXON technician.
- At least once every two months, check the tightness of all screws and fasteners.
- At least once a month, check the tightness of the fixing nuts of the wheels' pins with a torque wrench calibration at 40Nm.
- Before each use, check proper operation of the accelerator and brakes: any replacement of parts subject to wear (brake pads, discs, brake system in general) should be carried out only by authorised KLAXON technicians. The vehicle should also be checked whenever you feel the braking power has decreased.
- Check the condition of the battery, before each use. To replace the battery, and any other electrical component, contact only authorised KLAXON technicians.

	Have a KLAXON qualified technician overhaul the entire device at least once a year, and/or whenever a malfunction occurs.
DANGER	The device should be checked by a Klick Dealer whenever you feel that the braking power has decreased.

## 14.2 MALFUNCTIONS

If you encounter a malfunction during use of the KLICK device, contact KLAXON or of its authorised resellers.

Malfunction found	Possible cause	Corrective action
The device does not turn on	The battery is empty	Recharge the battery
	The battery is positioned improperly	Check the position of the battery by removing it and inserting it again, making sure that the electrodes are inserted in the appropriate spaces.
	General problems	Contact an authorised KLAXON service centre
It vibrates excessively during use	Loose screws	Contact an authorised KLAXON service centre
The Klick is not manoeuvrable	The front tyre is flat	Inflate tyre to 2.7 bar
	The front tyre is punctured	Contact an authorised KLAXON Dealer
The display lights up but the device does not move	Disconnected plug	Contact an authorised KLAXON service centre
You have problems coupling the traction unit to the connector	The connector is not adjusted properly	Contact an authorised KLAXON service centre
You have problems attaching the connector	There is dirt inside the coupling seat in the crossbeam	Clean the surfaces of the seat in the crossbeam and of the mounting system in the connector
You have problems attaching the connector	The interlocking balls do not retract when pulling the lever	Contact an authorised KLAXON service centre
Wheelchair front wheels touch the ground	The Klick coupling is mounted too low	Contact an authorised KLAXON service centre
KLICK is noisy when in use	The fender touches the wheel while moving	Make sure your feet are in a position that does not interfere with the fender of the device Reposition the fender, putting it back into place.
	The brake pads touch the disc when reversing	Contact an authorised KLAXON service centre

	Do not operate the Klick device whenever it behaves abnormally. Immediately contact a Klaxon Dealer
---	---

## 14.3 RACE BATTERY (11 AH)

The RACE battery (48 V X 11 Ah) is box-shaped and secured to the connection with a latching system (Figure 42).

On the side of the battery, there are markings along which some LEDs show the current charge level. Pressing the button, the LEDs will show the approximate charge level, in four levels (20%-50%-80%-100% - Figure 43).

The key, placed on the right side of the battery, can be used to remove the entire unit from the device; by turning it 180° anticlockwise, the battery is released and it can be removed by pulling it upward (Figures 44 and 45).

The black power button is located on the left side of the battery next to the protective cap for the charger input; pressing it will activate the battery and power the motor and the display. With the same button the battery is deactivated.

To charge the battery:

- Turn the device off (by pressing and holding the **"POWER"** button);
- Remove the battery by turning the key (Figures 44 and 45).
- Remove the protection cap located on top of the battery (Figure 46).
- Connect the battery charger's plug (Figure 47);
- Connect the battery charger's plug to the 230V 50 Hz mains (Figure 39);
- The two LED lights on the upper surface of the battery charger (Figure 40) show its status:
  - Red-red: charging;
  - Green-red: charging complete, fully charged battery.
- When the battery is fully charged, first disconnect the plug from the mains socket and only then remove the plug from the battery.

#### 14.4 FLY RACE BATTERY (5.8 AH)

The FLY RACE battery (48 V X 5.8 Ah) is box-shaped and secured to the connection with a latching system (Figure 42).

On the side of the battery, there are markings along which some LEDs show the current charge level. Pressing the button, the LEDs will show the approximate charge level, in four levels (20%-50%-80%-100% - Figure 43).

The key, placed on the right side of the battery, can be used to remove the entire unit from the device; by turning it 180° anticlockwise, the battery is released and it can be removed by pulling it upward (Figures 44 and 45).



The black power button is located on the left side of the battery next to the protective cap for the charger input; pressing it will activate the battery and power the motor and the display. With the same button the battery is deactivated.

To charge the battery:







- Turn the device off (by pressing and holding the **"POWER"** button);
- Remove the battery by turning the key (Figures 44 and 45).
- Remove the protection cap located on top of the battery (Figure 46).
- Connect the battery charger's plug (Figure 47);
- Connect the battery charger's plug to the 230V 50 Hz mains (Figure 39);
- The two LED lights on the upper surface of the battery charger (Figure 40) show its status:
  - Red-red: charging;
  - Green-red: charging complete, fully charged battery.
- When the battery is fully charged, first disconnect the plug from the mains socket and only then remove the plug from the battery.

#### BATTERY OPTIONS (TRANSPORTATION):

- The batteries supplied with the Klick device are compliant with the EMC2004/108/EC regulation issued by the European Union regarding the CE Classification. It is therefore permitted to transport these batteries on a train, ship or airplane. Despite of this classification they are considered, according to the UN Recommendations on the Transport of Dangerous Goods, as dangerous material and classified as Class 9, respectively as: code UN3480 (Lithium Ion Batteries) if transported as single units and UN3481 (Lithium Ion Batteries Contained in Equipment) if transported while connected to the Klick device. This classification determines some restrictions regarding the transportation of the product by ship (IMDG Code) and by plane (ATA DGR) referring to: quantity of batteries transported, type of transport (if transported as single unit or connected to the device) and the Watt-hour value (Wh) of each single battery. In this regard, if you are planning to take your device with you, please contact directly the shipping company or the airline chosen for your travel. Below is a list of the available battery models supplied by KLAXON:
  - RACE battery: 48V X 11Ah (528 Wh)
  - FLY RACE battery: 48V X 5.8 Ah (280 Wh)
- We recommend paying attention to the charge level indicator! Always recharge when the level is low. We always advise you to recharge the battery after extended use or overnight. Lithium-ion batteries have no memory effect, so they must be charged without having to wait until they are completely discharged.
- Store the battery charger away from heat sources, in a dry place and protected from direct sunlight.

	When not using the battery, remember to charge it at least once a month.
	If you see that the battery is damaged, its housing is broken, if it swells or leaks, absolutely do not use it and contact KLAXON's Technical Support immediately.
	Only use the supplied battery charger together with the KLICK device: any damage or malfunction due to non-compliance with these instructions or use of products that do not comply with KLAXON's guidelines will not be covered by the warranty.

# KLAXON Mobility GmbH - ENG

	There is a risk of injury due to short-circuits and risk of electric shock if the battery charger has been damaged. Avoid using the battery charger if it has been dropped or damaged.
	Avoid using extension cords unless it is absolutely necessary. If you must use them, make sure in advance that they are undamaged and in excellent condition, to prevent fire hazards and electrical shock.
	Never recharge the batteries and operate the device at the same time, due to risk of injury to yourself and to others. Only recharge the battery when is NOT mounted on the device.
	Once the battery is fully charged, the charger automatically cuts the power supply. Do not leave the battery charger connected to the 230 V mains for too long after it has finished its charge cycle (green LED on).
	Always charge the battery in a well ventilated room and keep it away from flammable material.
	Always charge the battery before you start. Never use the device with an empty battery.

## 15. TECHNICAL DATA

### 15.1 CLASSIFICATIONS OF THE DEVICE

According to the Medical Devices Directive	Risk class I
Protection against electrical hazards	Class II
Degree of protection against direct and indirect contact	Type B
Use in oxygen-rich environments	No protection
Operating conditions	Device for continuous operation

### 15.2 PERFORMANCE

#	Feature	Value	Unit	Notes
1a	Available speeds	3; 6; 9; 12; 15	km/h	
2a	Range RACE 11 Ah battery	45-50	km	With charged battery, moderate speed, flat course and 75 kg user.
2b	Range FLY RACE 5.8 Ah battery	20-25	km	With charged battery, moderate speed, flat course and 75 kg user.
3	Maximum negotiable rated slope	6	°	With charged battery and 75 kg user.
4	Maximum negotiable obstacle height	50	mm	With charged battery and 75 kg user:
5	Motor power	250	W	750 W of peak power
6	Motor voltage	48	V	
7	Maximum weight of user	120	Kg	Consistently with the technical characteristics of the wheelchair to which it is attached.
8	Expected service life	5	years	Approximately 25.000 km.

# KLAXON Mobility GmbH - ENG

## 15.3 SIZE INFORMATION

### 15.3 A DIMENSIONAL DATA KLICK POWER STANDARD LIMITED EDITION/ KLICK POWER TETRA LIMITED EDITION

#	Feature	Value	Unit	Notes
1	Length	400	mm	
2	Width	500	mm	
3	Height	900	mm	Power Standard Limited Edition
		950	mm	Power Tetra Limited Edition
4	Weight	8.5	kg	Power Standard Limited Edition
		9.1	kg	Power Tetra Limited Edition
5a	Weight of RACE battery (11 Ah)	3.0	kg	
5b	Weight of FLY RACE battery (5.8 Ah)	1.5	kg	
6	Tyre Size	14X2,125	inch	C1488 ELECTRIC E-BIKE

## 15.4 ENVIRONMENTAL OPERATING CONDITIONS

#	Feature	Value	Unit	Notes
1	Maximum altitude	2000	m	
2	Atmospheric pressure	700 to 1060	hPa	
3	Temperature	-25 to 50	°C	0°C to 40°C is suggested for a better performance
4	Relative humidity	30 to 90	%	

## 15.5 TRANSPORTATION AND STORAGE ENVIRONMENTAL CONDITIONS

#	Feature	Value	Unit	Notes
1	Temperature	-40 to 65	°C	10°C to 50°C is suggested
2	Relative humidity	30 to 90	%	

NOTE	<p>Before a long term storage fully charge the battery.</p> <p>During a long term storage periodically check the battery charge and eventually charge it.</p> <p>Before starting to use the battery again after a long period of storage, fully charge the battery.</p>
------	---

## 15.6 TECHNICAL DESCRIPTION OF BATTERY CHARGER

NOTE	All KLAXON products are provided with a Li-Ion Maintenance Free battery.
------	--

## 15.6 A TECHNICAL DESCRIPTION OF BATTERY CHARGER (RACE, FLY RACE BATTERIES)

#	Feature	Value	Unit	Notes
1	Input voltage	230	V	
2	Frequency	50	Hz	
3	Output Voltage	48	V	

## 15.7 TECHNICAL DESCRIPTION OF BATTERIES

### A. RACE BATTERY (11 Ah)

#	Feature	Value	Unit	Notes
1	Rated voltage	48	V	

# KLAXON Mobility GmbH - ENG

2	Capacity	11	Ah	
3	Charging time	5.5	h	Time to charge a completely discharged battery



## B. FLY RACE BATTERY (5,8 Ah)

#	Feature	Value	Unit	Notes
1	Rated voltage	48	V	
2	Capacity	5.8	Ah	
3	Charging time	3.5	h	Time to charge a completely discharged battery

## 15.8 MAIN FEATURES

#	Feature	Value
1	Traction type	Electric
2	Brake	Disc (diameter 160 mm), mechanical
3	Type of use	Outdoor and indoor

## 16. DISPOSAL OF THE DEVICE

	Disposal of the equipment inside the KLICK devices must absolutely comply with regulations of the country in which the devices are used. KLAXON is not liable for use that is not in accordance with specific regulations in force.
	Recycling of Li-Ion batteries depend from National regulation, ask to your Klaxon Dealer to know your Country rules.

## 17. PRODUCT WARRANTY

The warranty period is 24 months for the traction device and 12 months for the batteries, starting from the delivery date of the device.

Natural wear and tear of parts is not covered by the warranty, except for improper wear due to a manufacturing defect.

If a defect occurs during the warranty period, KLAXON will, at its discretion, repair or replace the defective component.

The manufacturer assumes no liability for damages caused by negligence, careless use and maintenance, tampering or incorrect maintenance or by unauthorised persons, or for failure to follow the instructions for use set out in this Manual.

## 18. ADDENDUM

This manual is an addendum to the original "KLICK electric series Manual - rev.6.3 of 25.05.2020" supplied together with this document. If you need more information or have any doubts, please refer to the original manual.

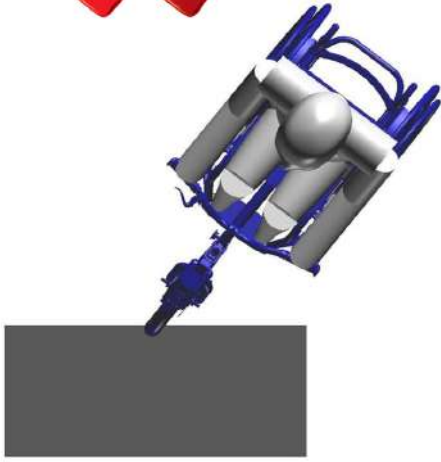
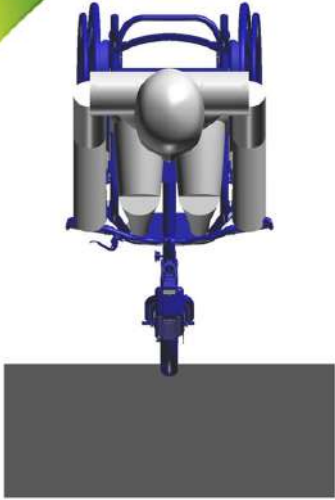

IT Figura / EN Pictures / DE Abbildung / FR Figure n° 2



IT Figura / EN Pictures / DE Abbildung / FR Figure n° 3

IT Figura / EN Pictures / DE Abbildung / FR Figure n° 1

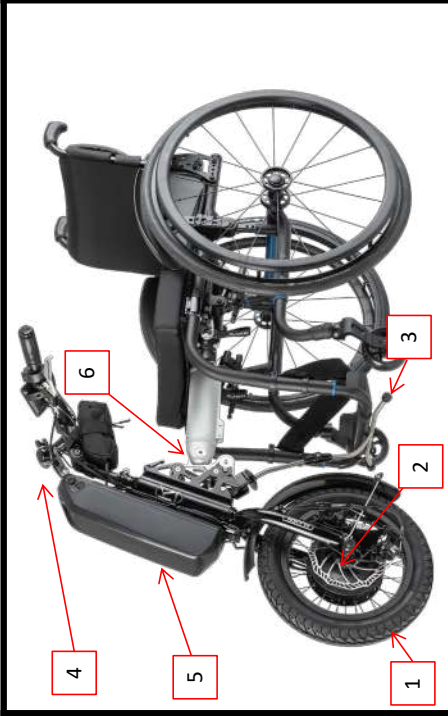

IT Figura / EN Pictures / DE Abbildung / FR Figure n° 4



IT Figura / EN Pictures / DE Abbildung / FR Figure n° 6

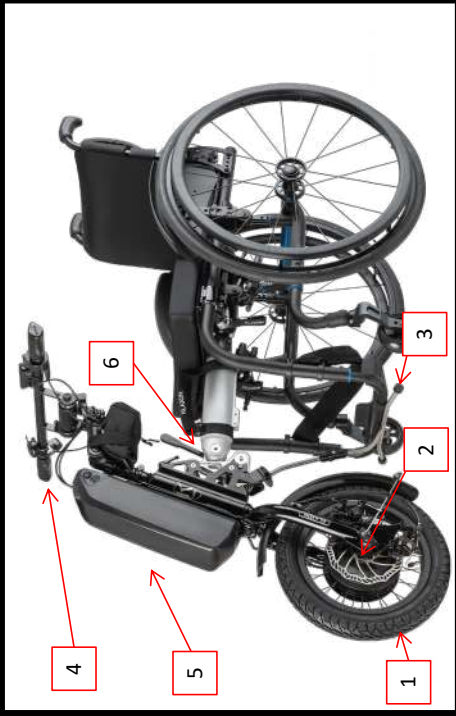

IT Figura / EN Pictures / DE Abbildung / FR Figure n° 5



IT Figura / EN Pictures / DE Abbildung / FR Figure n° 7



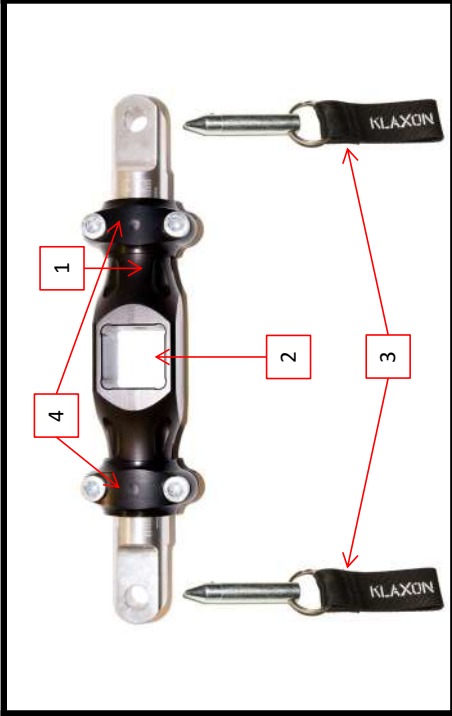

IT Figura / EN Pictures / DE Abbildung / FR Figure n° 8



IT Figura / EN Pictures / DE Abbildung / FR Figure n° 10

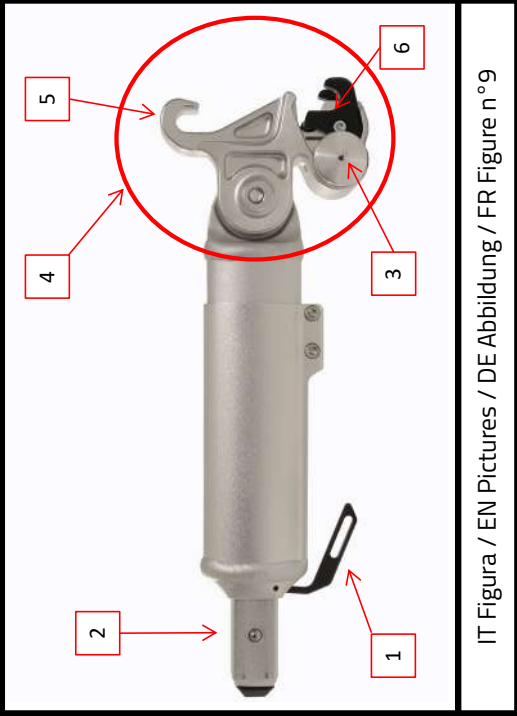

IT Figura / EN Pictures / DE Abbildung / FR Figure n° 9

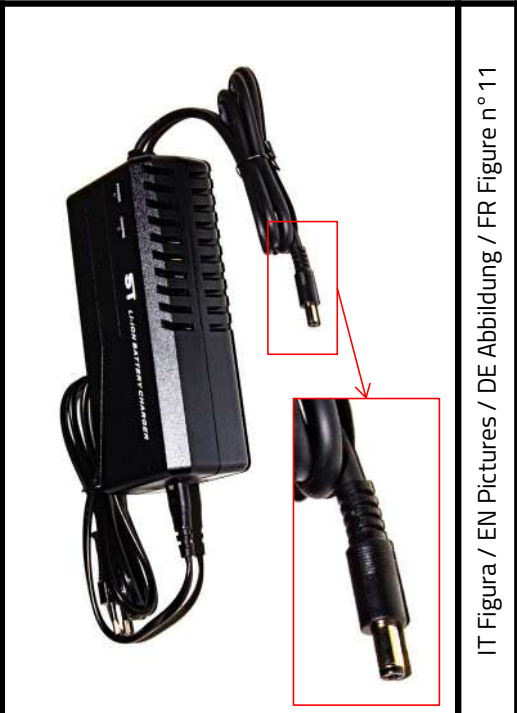

IT Figura / EN Pictures / DE Abbildung / FR Figure n° 11



IT Figura / EN Pictures / DE Abbildung / FR Figure n° 12



IT Figura / EN Pictures / DE Abbildung / FR Figure n° 14



IT Figura / EN Pictures / DE Abbildung / FR Figure n° 13



IT Figura / EN Pictures / DE Abbildung / FR Figure n° 15



IT Figura / EN Pictures / DE Abbildung / FR Figure n° 16



IT Figura / EN Pictures / DE Abbildung / FR Figure n° 18

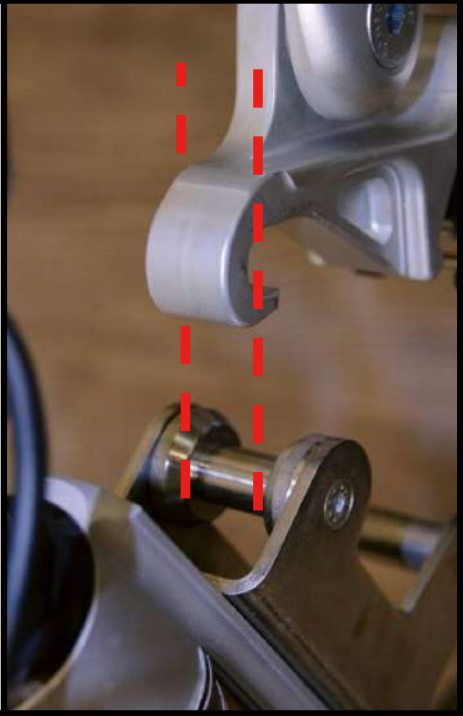

IT Figura / EN Pictures / DE Abbildung / FR Figure n° 17

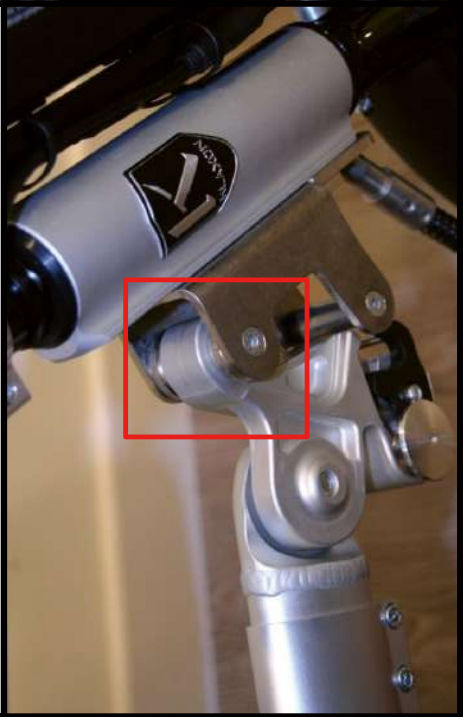

IT Figura / EN Pictures / DE Abbildung / FR Figure n° 19



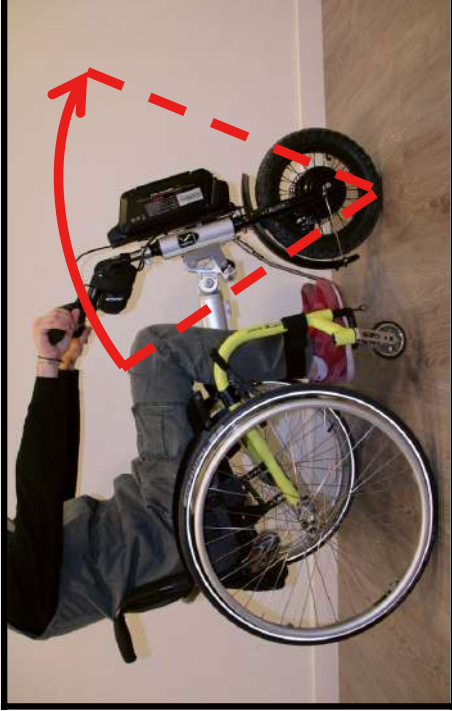

IT Figura / EN Pictures / DE Abbildung / FR Figure n° 20

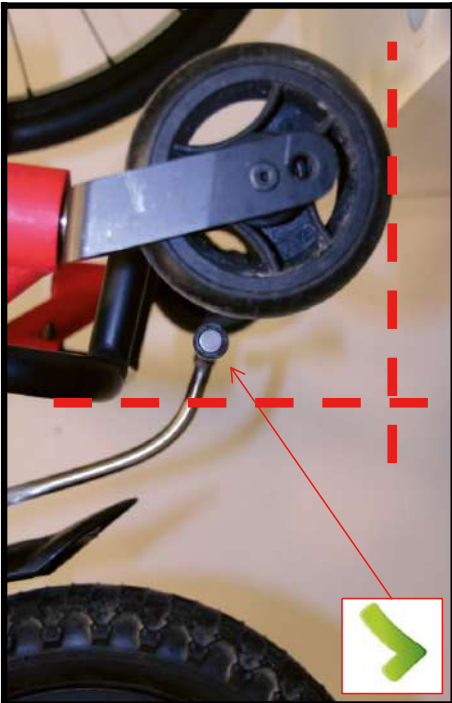

IT Figura / EN Pictures / DE Abbildung / FR Figure n° 22

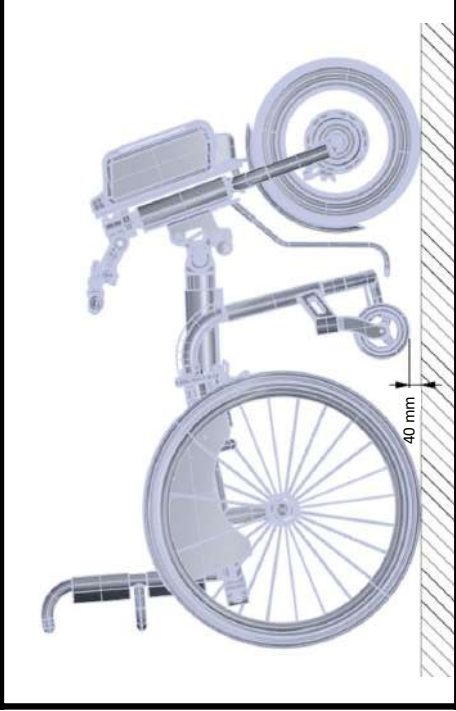

IT Figura / EN Pictures / DE Abbildung / FR Figure n° 21

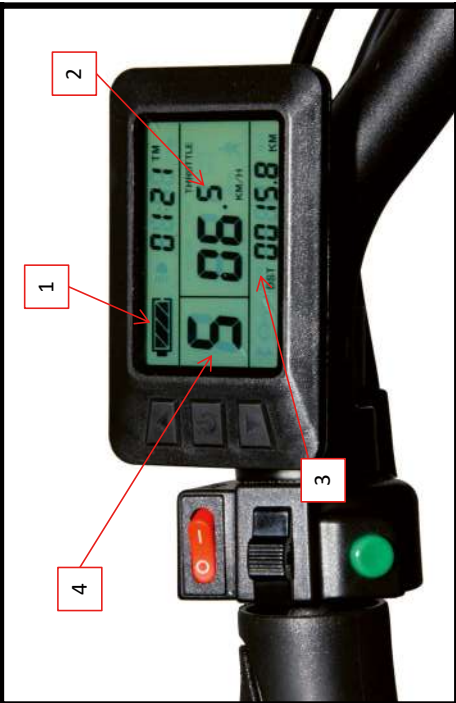

IT Figura / EN Pictures / DE Abbildung / FR Figure n° 23

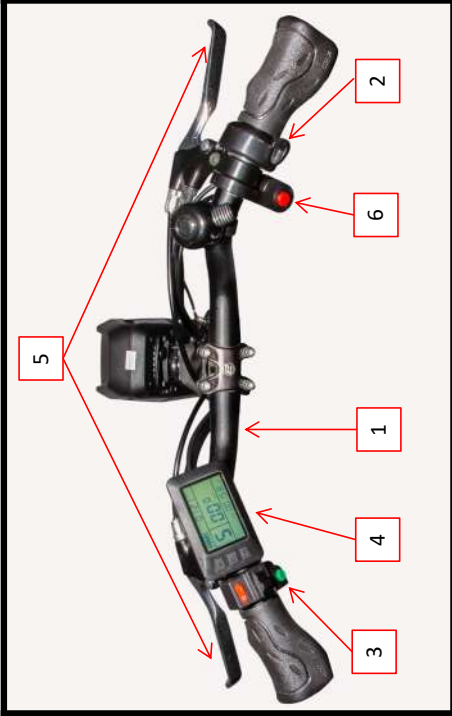

IT Figura / EN Pictures / DE Abbildung / FR Figure n° 24



IT Figura / EN Pictures / DE Abbildung / FR Figure n° 26.1



IT Figura / EN Pictures / DE Abbildung / FR Figure n° 25



IT Figura / EN Pictures / DE Abbildung / FR Figure n° 26.2



IT Figura / EN Pictures / DE Abbildung / FR Figure n° 27



IT Figura / EN Pictures / DE Abbildung / FR Figure n° 29



IT Figura / EN Pictures / DE Abbildung / FR Figure n° 28



IT Figura / EN Pictures / DE Abbildung / FR Figure n° 30



IT Figura / EN Pictures / DE Abbildung / FR Figure n° 31

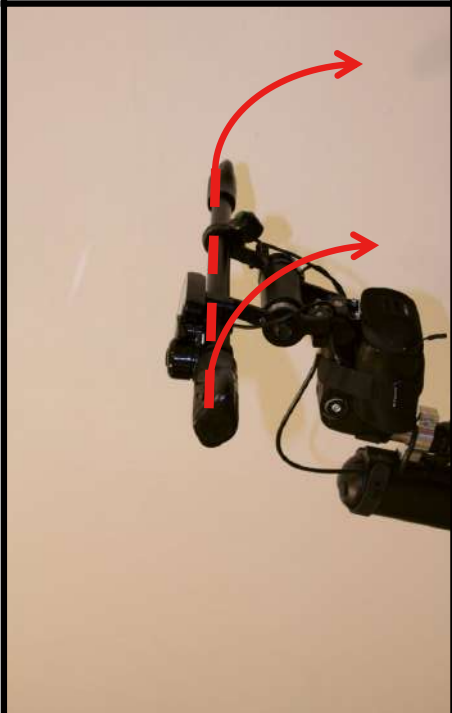

IT Figura / EN Pictures / DE Abbildung / FR Figure n° 33

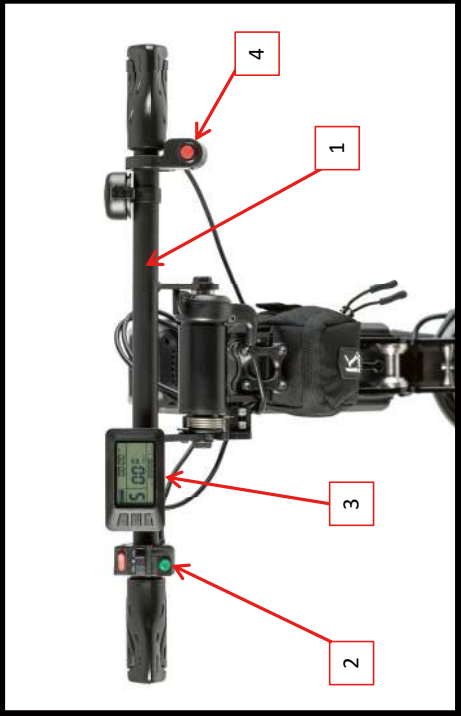

IT Figura / EN Pictures / DE Abbildung / FR Figure n° 32

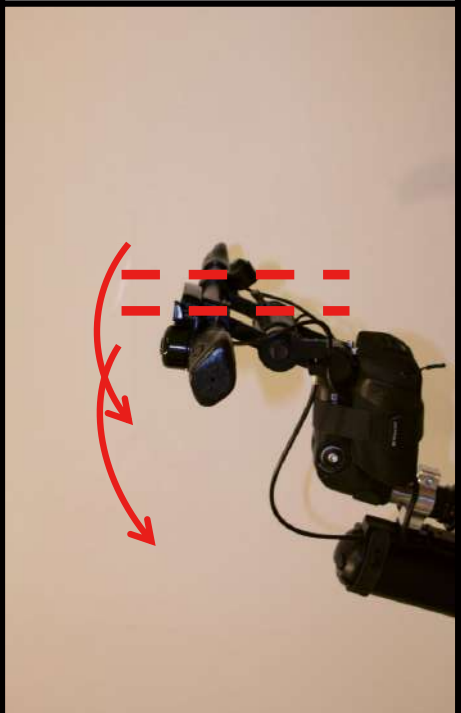

IT Figura / EN Pictures / DE Abbildung / FR Figure n° 34





IT Figura / EN Pictures / DE Abbildung / FR Figure n° 35



IT Figura / EN Pictures / DE Abbildung / FR Figure n° 37



IT Figura / EN Pictures / DE Abbildung / FR Figure n° 36



IT Figura / EN Pictures / DE Abbildung / FR Figure n° 38





IT Figura / EN Pictures / DE Abbildung / FR Figure n° 39



IT Figura / EN Pictures / DE Abbildung / FR Figure n° 41



IT Figura / EN Pictures / DE Abbildung / FR Figure n° 40



IT Figura / EN Pictures / DE Abbildung / FR Figure n° 42



IT Figura / EN Pictures / DE Abbildung / FR Figure n° 43



IT Figura / EN Pictures / DE Abbildung / FR Figure n° 45



IT Figura / EN Pictures / DE Abbildung / FR Figure n° 44



IT Figura / EN Pictures / DE Abbildung / FR Figure n° 46



IT Figura / EN Pictures / DE Abbildung / FR Figure n° 47

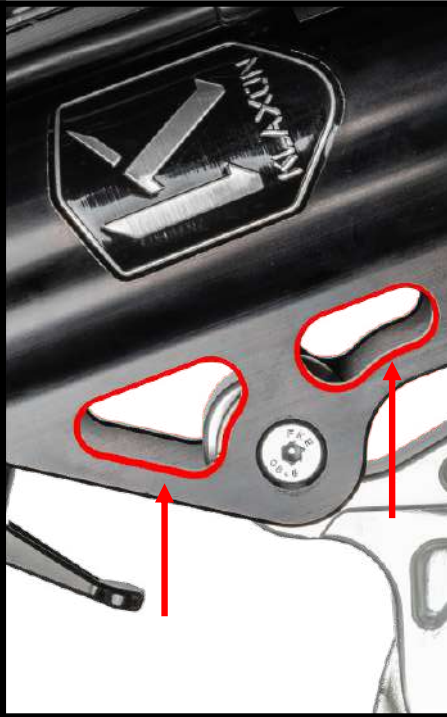

IT Figura / EN Pictures / DE Abbildung / FR Figure n° 49



IT Figura / EN Pictures / DE Abbildung / FR Figure n° 48



IT Figura / EN Pictures / DE Abbildung / FR Figure n° 50



IT Figura / EN Pictures / DE Abbildung / FR Figure n° 51



IT Figura / EN Pictures / DE Abbildung / FR Figure n° 53



IT Figura / EN Pictures / DE Abbildung / FR Figure n° 52



IT Figura / EN Pictures / DE Abbildung / FR Figure n° 54

**KLAXON**<sup>®</sup>  
the art of moving

**KLAXON MOBILITY GmbH**  
Industriestrasse, 1 – 9601 Arnoldstein (AT)  
[www.klaxon-klick.com](http://www.klaxon-klick.com)