

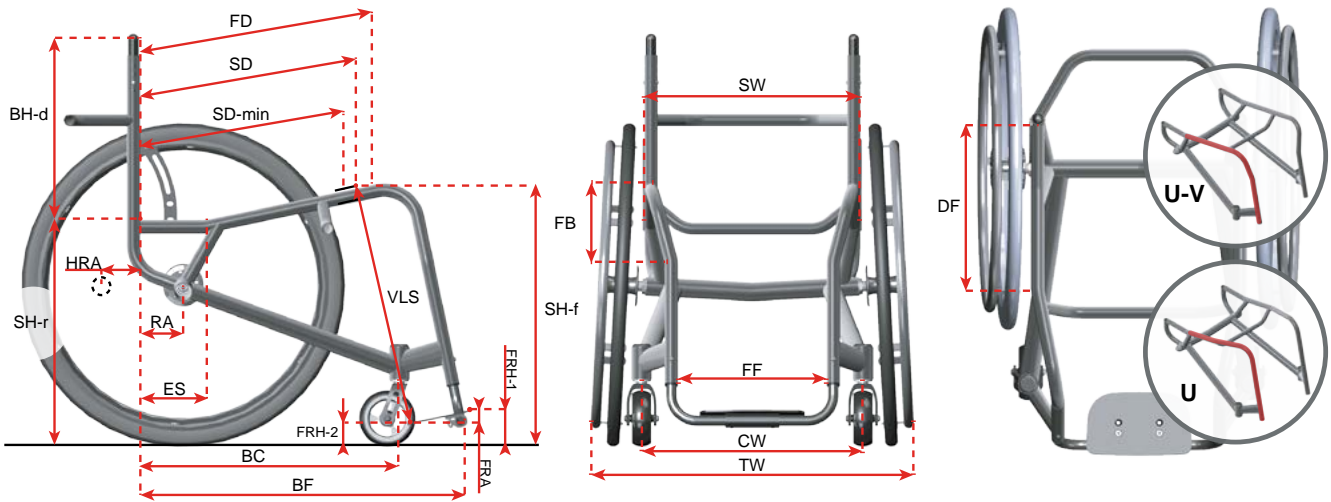

11100000100?	4900 €	1.	W5	150kg <i>max 48cm SW</i>
11100000300?	5200 €	2.	W5 S	150kg <i>max 48cm SW</i>
11100000400?	4900 €	3.	W5 K	150kg <i>max 48cm SW</i>
11100000200?	4900 €	4.	W5 D	150kg <i>max 48cm SW</i>
11100000550?	5700 €	5.	W5 XXL	250kg
120000001500	4900 €	6.	Tukan A*	120kg <i>max 45cm SW</i>
120000002000	4900 €	7.	Tukan B*	120kg <i>max 45cm SW</i>
120000003000	4900 €	8.	Tukan C*	120kg <i>max 45cm SW</i>
120000004000	4900 €	9.	Tukan D*	120kg <i>max 45cm SW</i>
14100000150?	4950 €	10.	Dalton	150kg <i>max 48cm SW</i>
141000001800	5800 €	-	Dalton XXL	Std. 160kg HD 250kg
+829999030030	1653 €	11.	HD	250kg

619000001009	0 €		
619000001109	0 €		
619000001209	0 €		
619000001309	0 €		
619000001409	0 €		
619000001509	0 €		
619000002009	0 €		
619000002109	0 €		
619000002509	0 €		
619000002809	0 €		
619000003209	0 €		
619000003309	0 €		
619000003409	0 €		
619000003509	0 €		
619000003709	0 €		
619000003809	0 €		
619000003909	0 €		
619000003009	780 €		
	0 €		
000000001102	0 €		



		!		SW: _____ cm
		!		FD: _____ cm std. 44cm
		!		SD: _____ cm std. 41cm
		!		SD _{min} : _____ cm optimized
		!		SH-r: _____ cm std. 42cm
		!		SH-f: _____ cm std. 48cm
		!		BH: _____ cm std. 35cm
		!		C: _____ ° std. 3°
	!			RA: _____ cm std. 8cm
69100001010?	760 €			HRA: _____ cm std. 5cm
61000001009	0 €			
610000??0001	265 €			ES: _____ cm std. 12cm
				BF: _____ cm std. 60cm
			Std. BF-10cm Dalton FD+8cm	BC: _____ cm std. 50cm
				CW: _____ cm FF+15cm
				TW: _____ cm SW+17cm
612000??0009				FB: _____ cm std. 15cm
613000??0009	!			DF: _____ cm std. 30cm
613000000009				
			Std. Ø25: 25,5 – 27,5 – 29,5 – 32,5 – 35,5 cm Std. Ø30: 25,0 – 27,0 – 29,0 – 32,0 – 35,0 cm	FF: _____ cm

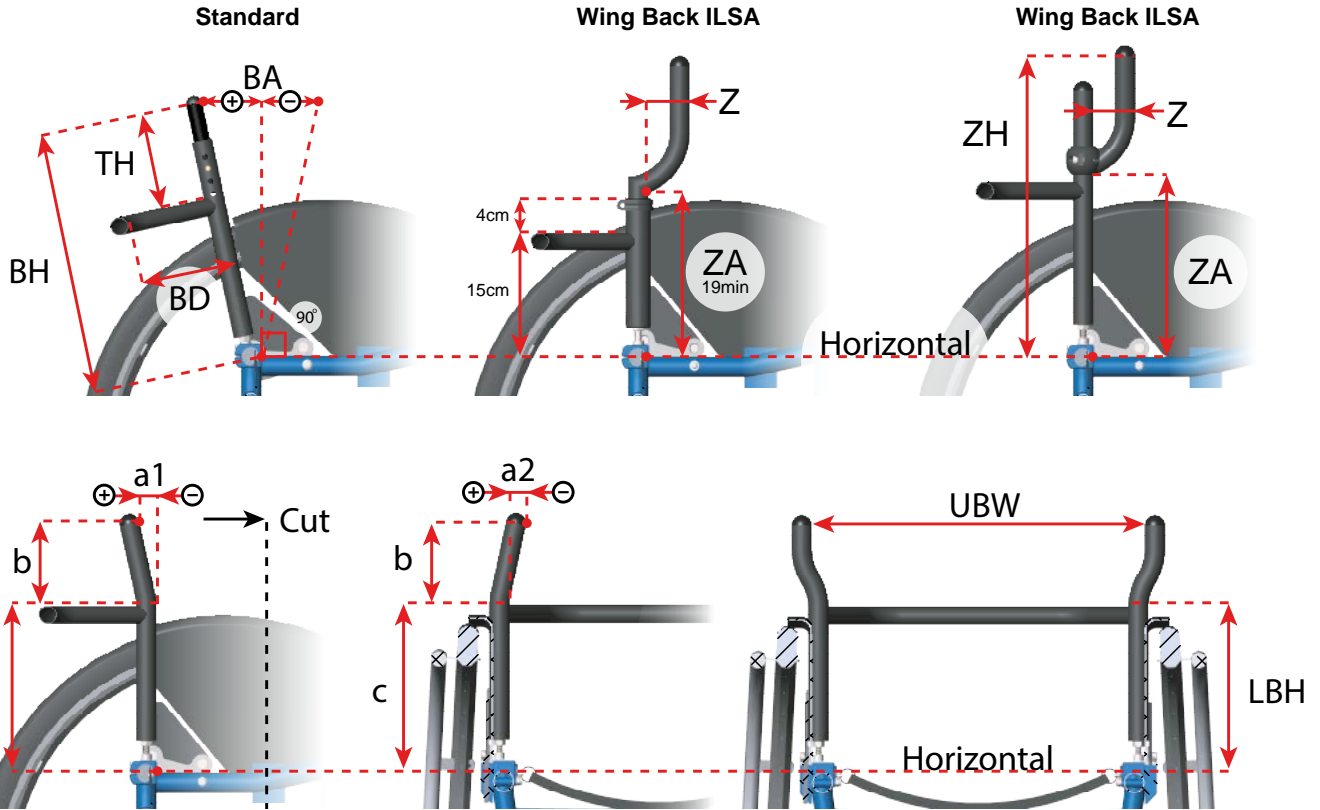

		!		BA: std. 0cm _____ cm
813100050???	0 €		1	
813100051???	381 €		2	
691000010130	70 €		2+	
813100053???	519 €		3	
	0 €			
8122002001??	583 €			Z: 0cm 3cm 5cm 7cm 10cm
8122002001??	754 €			ZH: std. BH _____ cm
				ZA: std. 19cm _____ cm
8122002001??	969 €			Z: std. 5cm _____ cm
	969 €			ZH: std. BH _____ cm
				ZA: std. 19cm _____ cm
825000000038	0 €			BD: std. 12cm _____ cm
825000000048				TH: std. 12cm _____ cm
812200200002	256 €			UBW: SW+/-3cm _____ cm
812200200001				LBH: std. 20cm _____ cm
812200200020	153 €			a1: std. +1cm _____ cm
				a2: std. +0cm _____ cm
				b: std. 15cm _____ cm
				c: std. 20cm _____ cm

Fill in and send to Wolturnus - Ausfüllen und an Wolturnus senden - Udfyld og send til Wolturnus

Subject to Technical Modifications and Printing Errors / Tekniske ændringer og trykfejl

© Wolturnus A/S W57Tukan/Dalton Winter 2026 v16.1

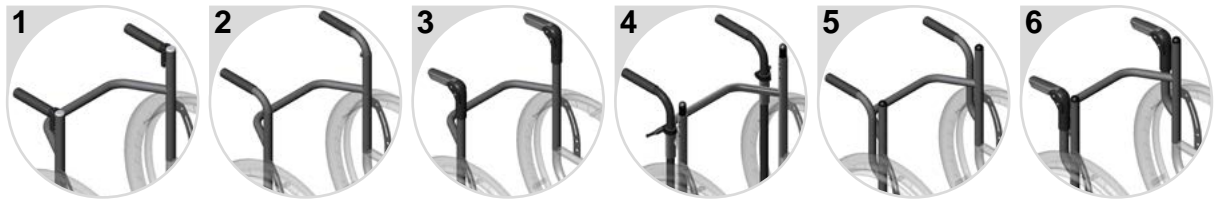

81310005??0?	0 €		-		
81310005?106	327 €		1.		
81310005?206	383 €				
81310005?108	327 €		2.		
81310005?208	383 €				
81310005?107	191 €		3.		
81310005?207	240 €				
81310005??02	574 €		4.		
81310005??03	574 €				
81310005??04	383 €		5.		
81310005??05	601 €		6.		
					PH: std. SH-r + BH _____ cm

	0 €				
8861101013??	339 €		a.		
	339 €				
	678 €				
	339 €				
88611010130?	339 €		b.		
	339 €				
	678 €				
	339 €				
8861101013??	443 €		c.		
	443 €				
	886 €				
					AF: 5-6cm _____ cm AW: 35-36cm _____ cm

691000020020	286 €				
691000020020	286 €				
886210101001	354 €				
886210101001	354 €				

--	--	--	--	--	--

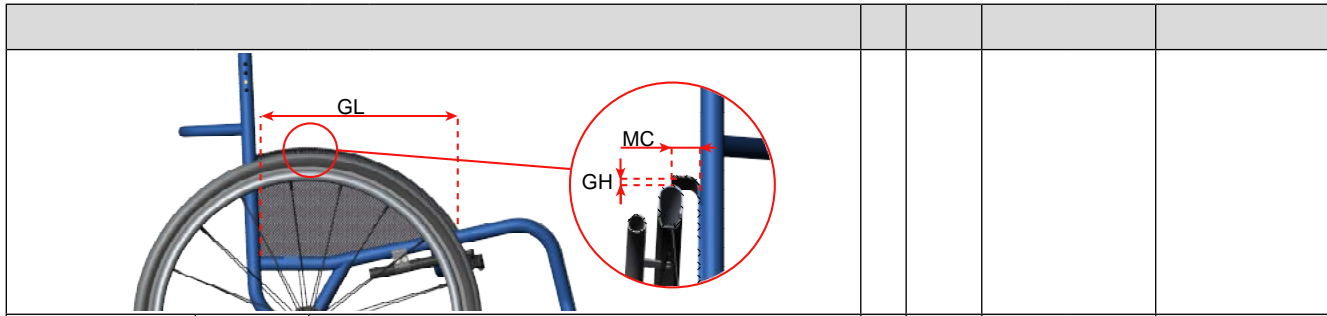

881000600003	0 €			
88100010000?	0 €			
881000?0000?	350 €			
88100040000?	313 €			
8810002000??	741 €			
88100050000?	775 €			
881000500022	775 €			
881000500012	775 €			
881000500032	775 €			
881000500042	775 €			
881000500052	775 €			
881000500062	775 €			
881000500005	775 €			
883124101034	1092 €			
8810003000??	775 €			
881000300022	775 €			
881000300012	775 €			
881000300032	775 €			
881000300042	775 €			
881000300052	775 €			
881000300062	775 €			
881000300005	775 €			
883124101030	1057 €			
-	0 €			

	0 €			
681000010007	77 €			
681000010004	184 €			
883124101014	250 €			
681000010052	77 €			

				GH: std. 1,0cm _____ cm GL: follow tire _____ cm MC: center _____ cm
--	--	--	--	--

767000000010	177 €			SW-s = SW-6mm
767000000013	177 €			SW-s = SW-20mm
767000000014	177 €			SW-s = SW-40mm

--	--	--	--	--

WOLTURNUS

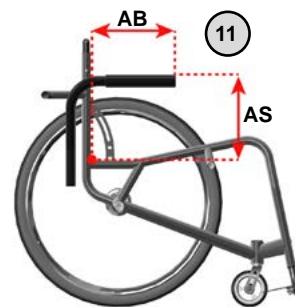
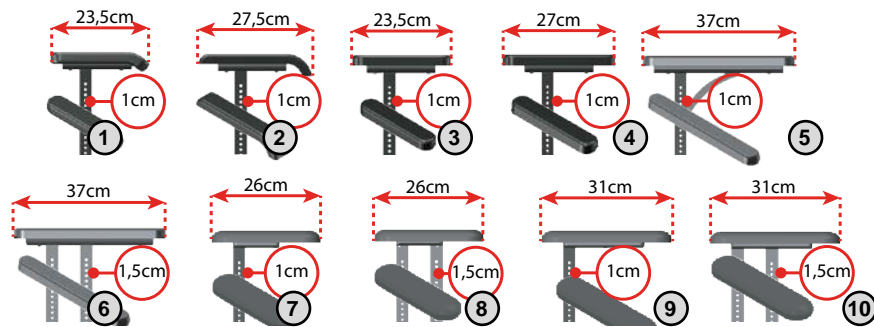

	0 €		-	
88100100003	573 €		1.	AB = 29 cm (Max. 150kg)
88100110003	573 €		2.	AB = 30,5 cm (Max. 150kg)
88100120003	573 €		3.	AB = 27,5 cm (Max. 150kg)
88100130003	573 €		4.	AB = 30 cm (Max. 150kg)
881001?0003	834 €		5.	AB = 41 cm (Max. 150kg)
881001?0003	990 €		6.	AB = 41 cm (Max. 250kg)
881001?0003	886 €		7.	AB = 31 cm (Max. 150kg)
881001?0003	1042 €		8.	AB = 31 cm (Max. 250kg)
881001?0003	886 €		9.	AB = 34,5 cm (Max. 150kg)
881001?0003	1042 €		10.	AB = 34,5 cm (Max. 250kg)
883124101002	578 €		11.	AB: std. 35cm _____ cm AS: std. 26cm _____ cm

	0 €		0.	
885110101001	0 €		1.	
885110101003	0 €		2.	
885110111001	207 €		3.	
885110122002	122 €		+	
885110201009	163 €		4.	
885110200909	207 €		5.	
885110101101	207 €		6.	
885110111101	207 €		7.	
951519204000	188 €		+	
885110201209	235 €		8.	
885110201300	261 €		9.	
840000207242	469 €		10.	
840000207239	469 €			
9515?????00??	0 €		x	
691000020001	179 €		y	
-	179 €		z	
	0 €		-	

Fill in and send to Wolturnus - Ausfüllen und an Wolturnus senden - Udfyld og send til Wolturnus

	0 €		1.					
710000001110	0 €		2.					
-	0 €		+				+0	+1
-	0 €		+				+0	+1
710000001120	327 €		3.					
710099990010	459 €							
710000002502	0 €		+				+0	+1
-	0 €		+					+2
761000000010	10 €		+				+0	+1
750000000103	+ €		+					+2

710099990001	0 €		1.					
710000001?20	208 €		2.					

710000000000	0 €		1.					
725029351009	163 €		2.					
725029351009	163 €		3.					
-	0 €		4.					





750000009000	275 €		1.					
750000000001	0 €		+					
750000000005	71 €		+					
750000000006	71 €		+					
			!				5cm	7cm
							5cm	7,5cm
75000000000?	71 €							

W: _____ cm
std. SW
D: _____ cm
std. SD

76000010001	71 €		1.					
76000010015	65 €		2.					
761000000001	169 €		3.					
761000000002	235 €							
771100000751	118 €							
771100000750	118 €		4.					
771100000749	118 €							
771100000747	118 €		5.					



© Wolturnus A/S W57Tukan/Dalton Winter 2026 v16.1

		4"	5"	6"	
860010101401	0 €				
860010101253	0 €				
8600102009?0	186 €				
8600101020??	0 €				
	0 €				
	0 €				
	0 €				
	0 €				
860020000000	54 €				
860010201???	339 €				
	339 €				
	339 €				
	339 €				
	393 €				
	393 €				
				+	
860010202???	339 €				
	339 €				
				+	
	0 €				
	167 €				
	167 €				
	167 €				
955067070012	625 €				
955067070011	625 €				
862400001009	327 €				

		22"	24"	25"	26"	ERTRO
	0 €					
96622?0100??	0 €					(25-489) (25-540) (23-559) (25-590)
96622?01000?	72 €					(25-489) (25-540) (23-559) (25-590)
96622?010009	154 €					(25-489) (25-540) (23-559)
966224010021	154 €					(25-540)
966224010013	72 €					(25-540)
966224011008	72 €					(37-540)
966224010007	72 €					(37-540)

		22"	24"	25"	26"	
	0 €					
85102??01009	0 €					
85102?10100?	0 €					
8510??101002	268 €					
851124201009	491 €					
8537281110??	852 €					
	852 €					
8537281110??	1365 €					
	1365 €					

		22"	24"	25"	26"	
85352?101?09	933 €					
85352?102108	933 €					
85352?101208	933 €					
85352?101508	933 €					
85352?101308	933 €					
85352?101608	990 €					
85352?101408	990 €					
85352?101808	990 €					
85352?101708	990 €					
85352?101009	724 €					
85352?101?09	724 €					
85352?101209	724 €					
85352?101509	724 €					
85352?101309	724 €					
85362?241008	990 €					
85362?181208	990 €					
85362?181508	990 €					
85362?181308	990 €					
85352?181107	993 €					

953001040120	114 €					
--------------	--------------	--	--	--	--	--

		22"	24"	25"	26"	
	0 €					
85512?10200?	0 €					
85502?103009	186 €					
85552?000009	524/656 €					
8554202?0601	328 €					
8554262?0601	588 €					
8554272?0601	588 €					
8554282?0601	715 €					
8554282?0602	715 €					
8554302?0601	715 €					
8554502?060?	729 €					
8554502?060?	729 €					
			!			
85712?102009	186 €					

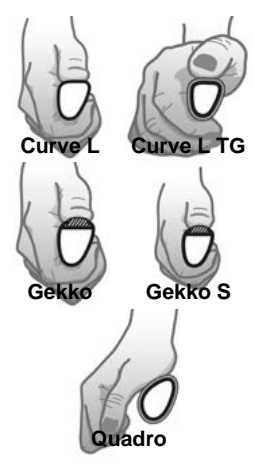

		i	
	0 €		
853727110001	1292 €		
853727110002	1292 €		
853727110004	1292 €		
853727110005	1292 €		
853727110007	1292 €		
951099250460	214 €		
951099250560	214 €		

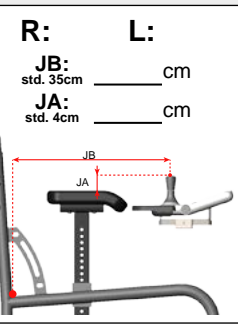

	0 €		
853728120000	239 €		
	239 €		



	0 €		
853728111039	NA €		
853728111062	607 €		
853728111061	607 €		
853728111064	595 €		
853728111063	595 €		
825000000007	120 €		

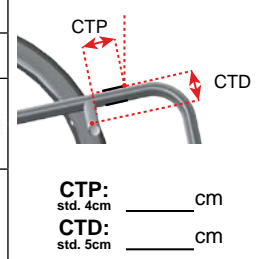

Fill in and send to Wolturnus - Ausfüllen und an Wolturnus senden - Udfyld og send til Wolturnus

Subject to Technical Modifications and Printing Errors / Technische Änderungen und Druckfehler vorbehalten
Forbehold for tekniske ændringer og trykfejl

© Wolturnus A/S W5/Tukan/Dalton Winter 2026 v16.1

--	--

--	--

000000001104 110 €			EN ISO 14971
------------------------------	--	--	--------------

--	--

P.4	
-----	--

P.5	
-----	--

P.6	
-----	--

P.7	
-----	--

P.8	
-----	--

P.9	
-----	--

P.10	
------	--

P.11	
------	--

P.12	
------	--

P.13	
------	--

P.14	
------	--

