



**Tailor-made Wheelchair**



171000005000 <b>5800 €</b>	
17100000500? <b>5900 €</b>	

Fill in and send to Wolturnus - Udfyld og send til Wolturnus

Subject to Technical Modifications and Printing Errors / Technische Änderungen und Druckfehler vorbehalten  
Forbehold for tekniske ændringer og trykfejl

619000001009		
619000001109		
619000001209		
619000001309		
619000001409		
619000001509		
619000002009		
619000002109		
619000002509		
619000002809		
619000003209		
619000003309		
619000003409		
619000003509		
619000003709		
619000003809		
619000003909		
619000003009 <b>780 €</b>		
000000001102 <b>0 €</b>		

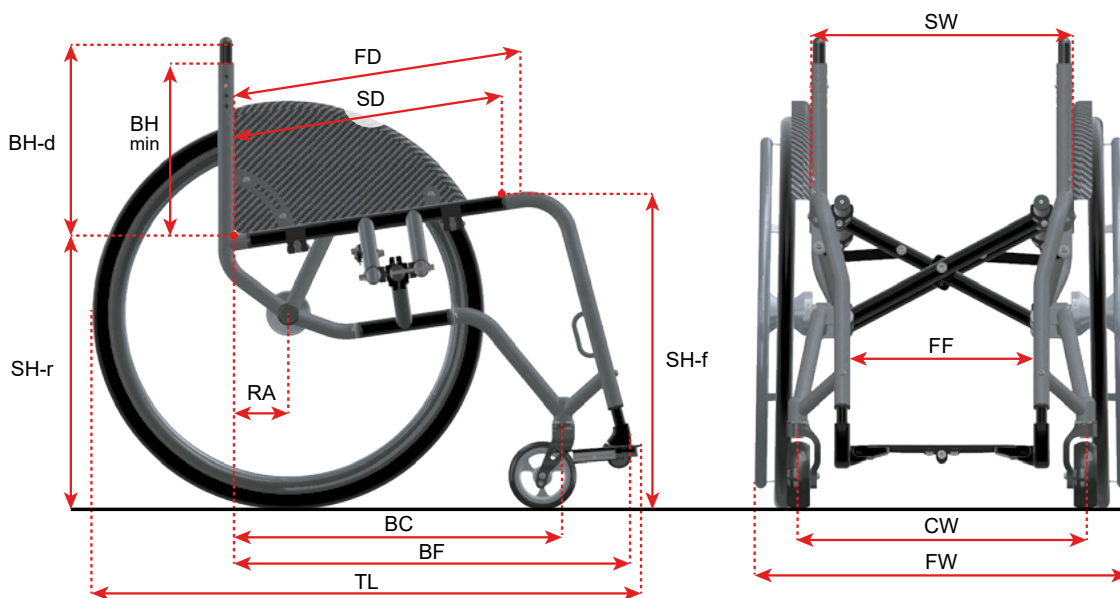

171000010??	!		<b>SW:</b> _____ cm
	!		<b>FD:</b> _____ cm
	!		<b>SD:</b> _____ cm
	!		<b>SH-r</b> _____ cm
	!		<b>SH-f:</b> _____ cm
			<b>C:</b> _____ °
	!		<b>BH:</b> _____ cm
			<b>BH-d:</b> _____ cm
			<b>BH-max:</b> _____ cm
			<b>BH-min:</b> _____ cm
	!		<b>RA:</b> _____ cm
			<b>BF:</b> _____ cm
			<b>BC:</b> _____ cm
			<b>CW:</b> _____ cm
			<b>TW:</b> _____ cm

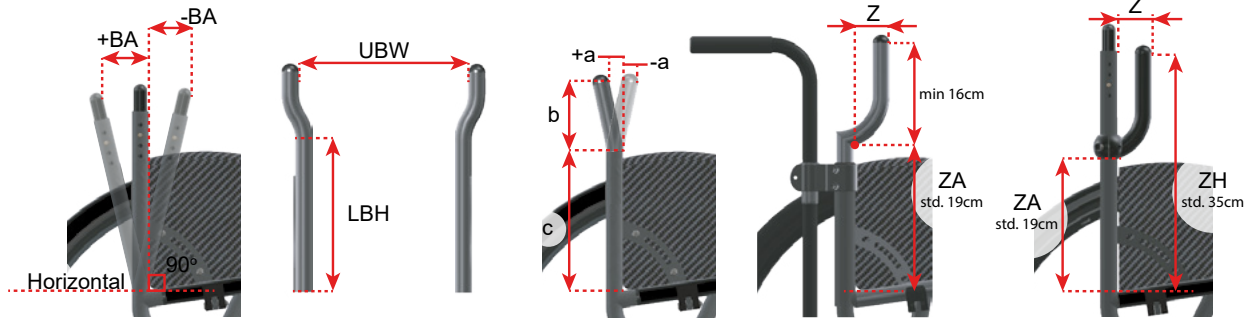

			<b>BA:</b> _____ ±cm	
812200200002 <b>256 €</b>			<b>UBW:</b> _____ cm	
812200200001 <b>256 €</b>			<b>LBH:</b> _____ cm	
812200200020 <b>153 €</b>			<b>a:</b> _____ cm	
			<b>b:</b> _____ cm	
			<b>c:</b> _____ cm	
8122002001?? <b>583 €</b>	!		_____ cm	
8122002001?? <b>754 €</b>				
82501000???? <b>583 €</b>				
8122002001?? <b>969 €</b>				<b>ZA:</b> _____ cm
8122002001?? <b>969 €</b>				<b>Z:</b> _____ cm
			<b>ZH:</b> _____ cm	
8861101013?? <b>339 €</b>				
8861101013?? <b>339 €</b>				
			<b>AF:</b> _____ cm	
			<b>AW:</b> _____ cm	



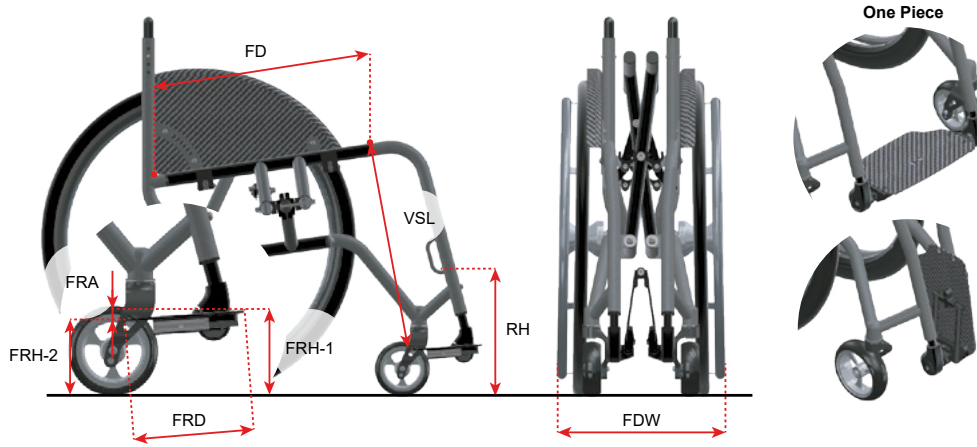

--	--



			VSL/USL: _____ cm
			FRH-1: _____ cm
			FRH-2: _____ cm
			-1,5   -3 +1,5   +3
			FRA: _____ cm
8350??010001 <b>0 €</b>			
8350??020001 <b>0 €</b>			
8350??030001 <b>0 €</b>			
8350??030001 <b>0 €</b>			
8350??050001 <b>480 €</b>		FF 22cm FF 24cm FF 26cm FF 28cm FF 30cm FF 32cm FF 34cm	
8350??060001 <b>727 €</b>		FF 22cm FF 24cm FF 26cm FF 28cm FF 30cm FF 32cm FF 34cm FF 36cm FF 38cm FF 40cm	
835099210001 <b>70 €</b>			
691000010001 <b>71 €</b>			RH: _____ cm

Fill in and send to Wolturnus - Ausfüllen und an Wolturnus senden - Udfyld og send til Wolturnus

Subject to Technical Modifications and Printing Errors / Technische Änderungen und Druckfehler vorbehalten  
Forbehold for tekniske ændringer og trykfejl

				1+	2+	3+
761000000010 <b>NA</b>						
710000000001 <b>0 €</b>						
710099990010 <b>459 €</b>						
710099990012 <b>490 €</b>						
710099990013 <b>490 €</b>						
710099990011 <b>490 €</b>						
710099990001 <b>0 €</b>						
710099990003 <b>193 €</b>						
710099990004 <b>193 €</b>						
710099990002 <b>193 €</b>						
710099990000 <b>0 €</b>						
750000009000 <b>275 €</b>						
- <b>0 €</b>						
750000000005 <b>71 €</b>		!				
					_____ cm / _____ cm	
					5cm Std.	7cm
					Medium Std.	Hard

© Wolturnus A/S Merlin Winter 2026 V5.0

				
881000100003 <b>0 €</b>				
881000600003 <b>0 €</b>				
881000?0000 <b>354 €</b>				
88100010000? <b>0 €</b>				
88100040000? <b>313 €</b>				
8810005000?? <b>775 €</b>				
88100020000? <b>741 €</b>				
8810003000?? <b>775 €</b>				

883124101014 <b>245 €</b>			
681000010002 <b>77 €</b>			
681000010052 <b>77 €</b>			
7670000000?? <b>177 €</b>			



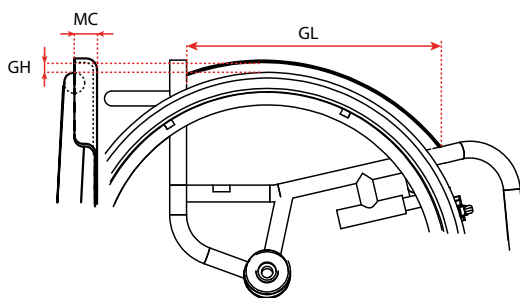

		<b>GH:</b>	_____ cm
		<b>GL:</b>	_____ cm
		<b>MC:</b>	_____ cm

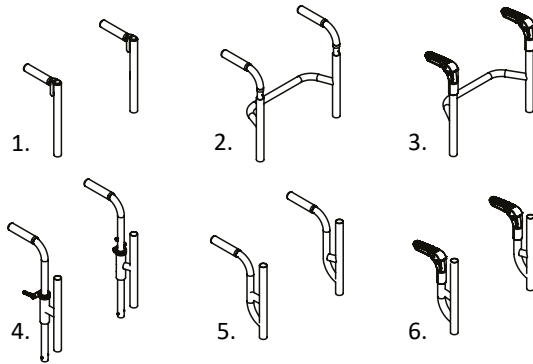



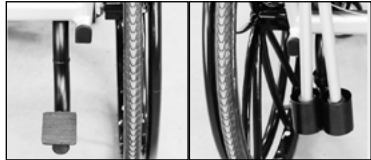

--	--



81310005?106 <b>327 €</b>	1.		
81310005?206 <b>383 €</b>			
81310005?108 <b>327 €</b>			
81310005?208 <b>383 €</b>	2.		
81310005?107 <b>191 €</b>			
81310005?207 <b>240 €</b>	3.		
81310005??02 <b>547 €</b>	4.		
81310005??04 <b>383 €</b>			
81310005??05 <b>601 €</b>			
			PH: _____ cm

69100002002? <b>286 €</b>			
886210101001 <b>354 €</b>			
7600000100?? <b>71 €</b>			
76100000000? <b>169 €</b> <b>235 €</b>			
7711000007?? <b>118 €</b> <b>118 €</b> <b>118 €</b>			 
771100000747 <b>118 €</b>			
953001040120 <b>114 €</b>			

--	--

885110101101 <b>207 €</b>			
885110111101 <b>207 €</b>			
885110201209 <b>235 €</b>			
885110201300 <b>261 €</b>			

951500020019 <b>72 €</b>			
-----------------------------	--	--	--

966401253410 966401003410		<b>186 €</b> <b>186 €</b>	
------------------------------	--	------------------------------	---



966401253400 966401003400 966401003403 966401003402 966401003401 966401003404		<b>0 €</b> <b>0 €</b> <b>0 €</b> <b>0 €</b> <b>0 €</b> <b>0 €</b>	
--	--	--	--



966401250120 966401250220 966401250320 966401250020		<b>338 €</b> <b>338 €</b> <b>338 €</b> <b>338 €</b>	
966401000120 966401000220 966401000320 966401000020		<b>338 €</b> <b>338 €</b> <b>338 €</b> <b>338 €</b>	
966401250?20 966401250620 966401250520 966401250420		<b>394 €</b> <b>394 €</b> <b>394 €</b> <b>394 €</b>	
966401000?20 966401000620 966401000520 966401000420		<b>394 €</b> <b>394 €</b> <b>394 €</b> <b>394 €</b>	

95210000000?		<b>0 €</b>	
		<b>0 €</b>	

--	--	--	--

	22"	24"	25"	26"	
85102??01009					0 €
85102?10100?	-			-	0 €
8510??101002				-	268 €
851124201009	-		-	-	491 €

	22"	24"	25"	26"		
85352?101008					933 €	
85352?101208					933 €	
85352?101508	-				933 €	
85352?101308					933 €	
85352?102108					933 €	
85352?101009					724 €	
85352?101209					724 €	
85352?101509	-				724 €	
85352?101309					724 €	
85352?101?09					724 €	

85352?101608					990 €	
85352?101408	-			-	990 €	
85352?101808					990 €	
85352?101708					990 €	
85362?241008					990 €	
85362?241208	-				990 €	
85362?241508					990 €	
85362?241308					990 €	
85362?181008					990 €	
85362?181208	-				990 €	
85362?181508					990 €	
85362?181308					990 €	

--	--

	22"	24"	25"	26"	
96622?010001				-	0 €
96622?01000?					72 €
96622?010009					154 €
96622?010021	-				154 €
966224010013	-		-	-	72 €
96622?011008	-		-	-	72 €
966224010007	-				72 €

85512?10200?					0 €
85512?102008	-			-	202 €
85502?103009	-				186 €
85552?000009					524 € 656 €
8554202?0601					328 €
8554262?0601	-				588 €
8554272?0601	-				588 €
8554282?0601					595 €
9669282?0602					595 €
8554302?0601					595 €
8554502?060?	-			-	729 €
8554502?060?	-			-	729 €

			!		
--	--	--	---	--	--

85712?102009					186 €
--------------	--	--	--	--	-------

--	--	--	--	--	--

000000001104 110 €					
-----------------------	--	--	--	--	--

EN ISO 14971

--	--	--	--	--	--

P.4	
P.5	
P.6	
P.8	
P.9	
P.10	
P.11	
P.12	





