

FAUTEUIL ROULANT SUR MESURE



210000001000 4900 €		

Fill in and send to Wolturnus - Ausfüllen und an Wolturnus senden - Udfyld og send til Wolturnus

Subject to Technical Modifications and Printing Errors / Technische Änderungen und Druckfehler vorbehalten
 Forbehold for tekniske ændringer og trykfejl

619000001009			
619000001109			
619000001209			
619000001309			
619000001409			
619000001509			
619000002009			
619000002109			
619000002509			
619000002809			
619000003209			
619000003309			
619000003409			
619000003509			
619000003709			
619000003809			
619000003909			
619000003009			
780 €			
000000001102			
0 €			

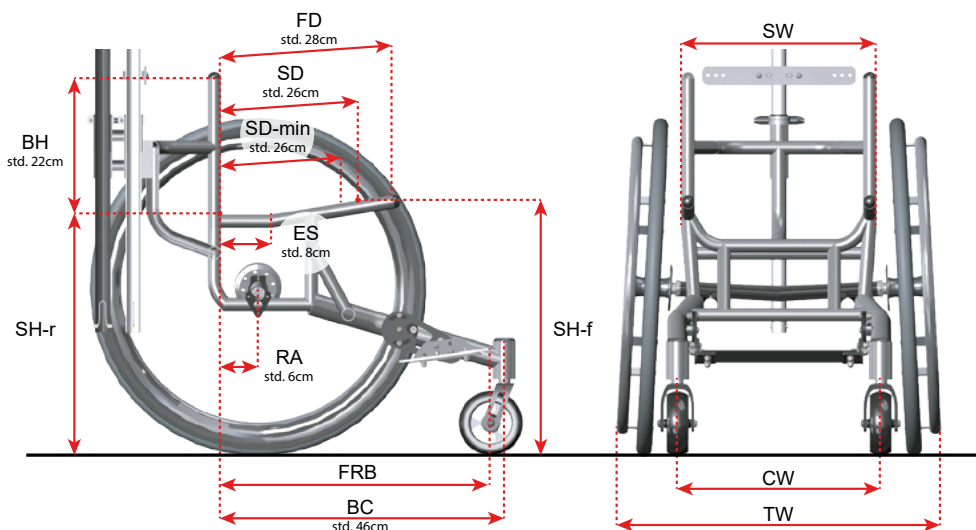

	!		SW: _____ cm
	!		FD: _____ cm
			SD: _____ cm
			SD-min: _____ cm
	!		SH-r _____ cm
	!		SH-f: _____ cm
	!		C: _____ °
812199000010 58 € 812199000011 58 €			BH: _____ cm
	!		BH-d: _____ cm
			BH-max: _____ cm
			BH-min: _____ cm
		!	RA: _____ cm
610000001009 610000??0001 265 €		!	ES: _____ cm
			BC: _____ cm
			CW: _____ cm
			TW: _____ cm

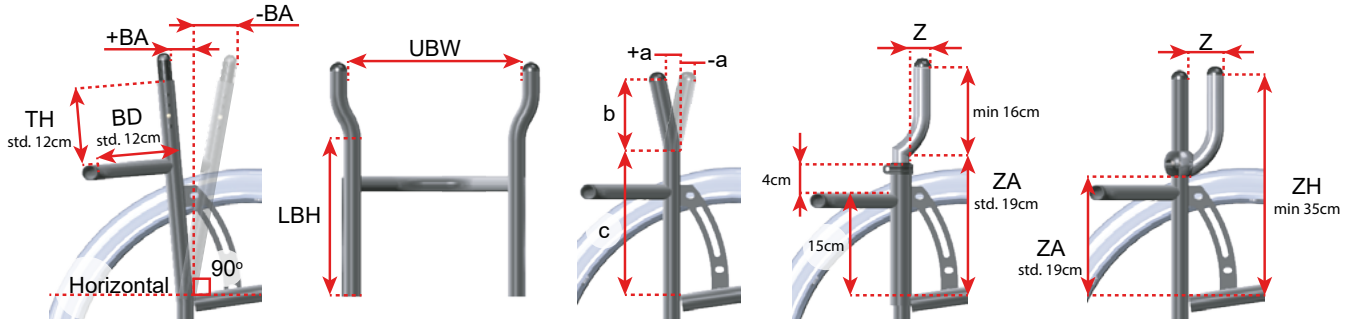

813100050???					
0 €					
813100051???					BA: _____ ±cm
381 €					
813100051???					
					BD: _____ cm
					TH: _____ cm

8122002001??					
583 €					
8122002001??					_____ cm
754 €					
82501000????					
583 €					ZA: _____ cm
8122002001??					Z: _____ cm
969 €					ZH: _____ cm
8122002001??					
969 €					

8861101013??					
339 €					
8861101013??					
339 €					
886110102001					AF: _____ cm
339 €					AW: _____ cm



--	--

Fill in and send to Wolturnus - Ausfüllen und an Wolturnus senden - Udfyld og send til Wolturnus

Subject to Technical Modifications and Printing Errors / Technische Änderungen und Druckfehler vorbehalten
Forbehold for tekniske ændringer og trykfejl

© Wolturnus A/S W5jr. Winter 2026 v6.0

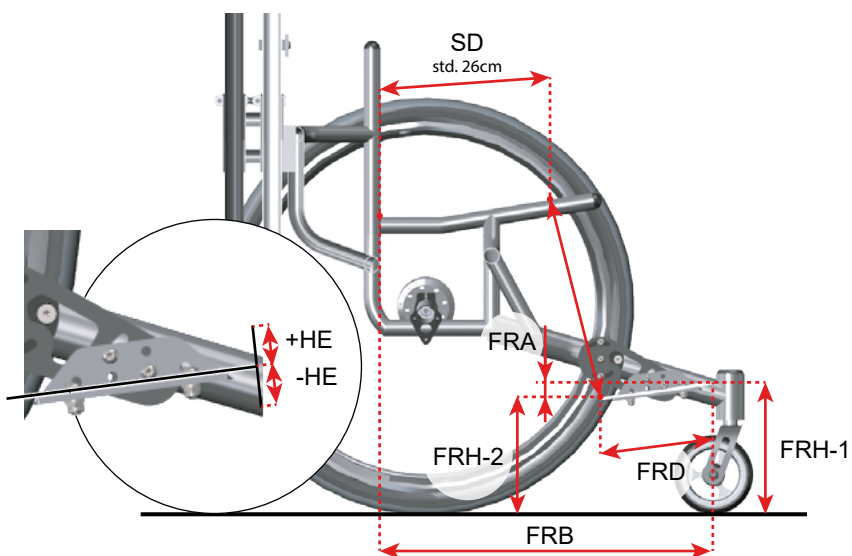

			VSL/USL: _____ cm
			FRH-1: _____ cm
			FRH-2: _____ cm
			-1,5 -3 +1,5 +3
823028991500 0 €			FRB: _____ cm
821920869000 520 €			FRD: _____ cm
			FRA: _____ cm
835099210001 70 €	!		
829999012001 39 €			HE: _____ ±cm

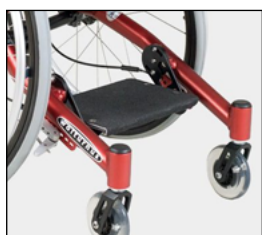

--	--



<p>885110101001 0 €</p>			
<p>885110101003 0 €</p>			
<p>885110111001 207 €</p>			
<p>885110122002 61 € 88511012200? 122 €</p>			
<p>885110301009 702 € 885110301009 702 €</p>			
<p>885110101101 207 €</p>			
<p>885110111101 207 €</p>			
<p>951519204000 94 € 188 €</p>			
<p>885110201209 235 €</p>			
<p>885110301015 867 €</p>			

--	--

Fill in and send to Wolturnus - Ausfüllen und an Wolturnus senden - Udfyld og send til Wolturnus

Subject to Technical Modifications and Printing Errors / Technische Änderungen und Druckfehler vorbehalten
Forbehold for tekniske ændringer og trykfejl

© Wolturnus A/S W5jr. Winter 2026 v6.0

				
881000100003 0 €				
881000600003 0 €				
881000?0000 354 €				
88100010000? 0 €				
88100020000? 741 €				
88100030000? 775 €				



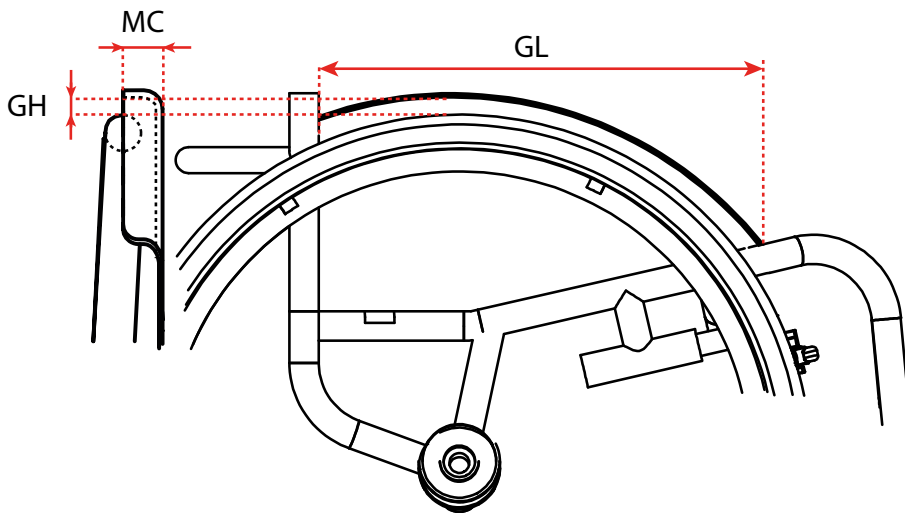

681000010002 77 €			
7670000000?? 177 €			

	GH:	_____ cm
	GL:	_____ cm
	MC:	_____ cm

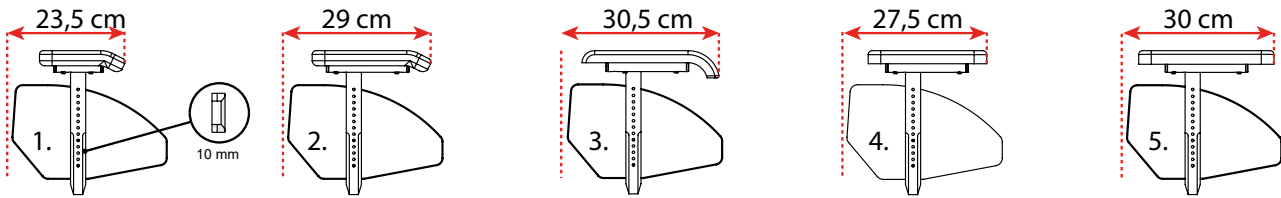

--	--

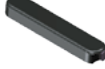

951000080119 573 €			AB = 23,5 cm AL = 16 cm	
881001000003 573 €			AB = 29 cm AL = 23,5 cm	
881001100003 573 €			AB = 30,5 cm AL = 27,5 cm	
881001200003 573 €			AB = 27,5 cm AL = 23,5 cm	
881001300003 573 €			AB = 30 cm AL = 27 cm	
681000010007 77 €				

!	AS: _____ cm
---	--------------

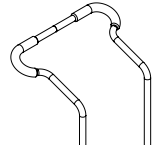
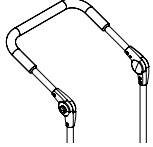
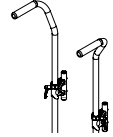

885200031005 398 €				
88520003100? 677 €				
88520003100? 677 €				
88520003100? 677 €				
88520003100? 677 €				
885200011501 547 €			5 cm 10 cm 15 cm	
	!			_____ cm

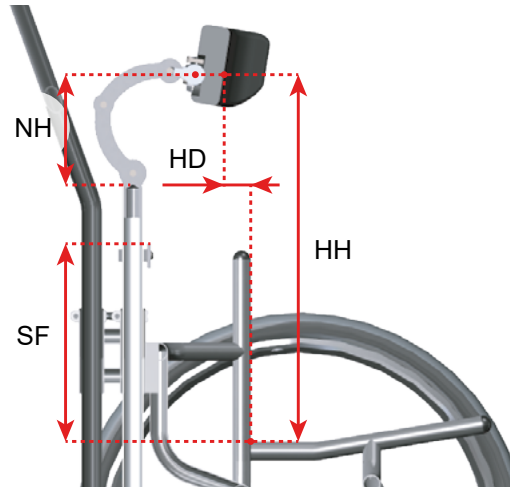
--	--



Fill in and send to Wolturnus - Ausfüllen und an Wolturnus senden - Udfyld og send til Wolturnus









Subject to Technical Modifications and Printing Errors / Technische Änderungen und Druckfehler vorbehalten
Forbehold for tekniske ændringer og trykfejl

884100013001 250 €					
884100014001 360 €					
951000080130 97 €					NH: _____ cm
951000080131 118 €					
951000080141 118 €					HH: _____ cm
951000080142 118 €					
840000100831 221 €					HD: _____ cm
840000100832 221 €					
884100250100 198 €					SF: _____ cm

887000200001 519 €					
------------------------------	--	--	--	--	--



7600000100?? 71 € 65 €					
--	--	--	--	---	--



--	--

860010201251	0 €	Std.	LED
860010201000	0 €	 	
860010201001	0 €		
860010200801	0 €		
860010101401	0 €	40mm	
860010101253	0 €		
860010101002	0 €		
860010200910	186 €		
860010200900	186 €		
8600101015??	491 €		
8600101015??	491 €		
86001010201?	0 €		
	0 €		
	0 €		
8600101020??	0 €		
	0 €		
860020000000	+53 €		
86001020150?	339 €		
	339 €		
860010201???	339 €		
	339 €		
	339 €		
860010201???	339 €		
	339 €		
	339 €		
	339 €		
860010201???	393 €		
	393 €		
	393 €		
	393 €		
860010201???	393 €		
	393 €		
	393 €		
	393 €		
	0 €		
	167 €		
	167 €		
	167 €		
885201001001	613 €		
862400001009	327 €		

--	--

	20"	22"	24"			
85102??01009				0 €		
85102?10100?	-	-		0 €		
8510??101002	-			268 €		
851124201009	-	-		491 €		
853728111019 853728111020	-			852 €		!
8537281110??	-			1.365 €		!

	20"	22"	24"		
85352?101008				933 €	
85352?101208				933 €	
85352?101508	-			933 €	
85352?101308				933 €	
85352?102108				933 €	
85352?101009				724 €	
85352?101209				724 €	
85352?101509				724 €	
85352?101309				724 €	
85352?101?09				724 €	

85352?101608				990 €	
85352?101408				990 €	
85352?101808	-	-		990 €	
85352?101708				990 €	
85362?241008				990 €	
85362?241208				990 €	
85362?241508	-	-		990 €	
85362?241308				990 €	
85362?181008				990 €	
85362?181208				990 €	
85362?181508	-	-		990 €	
85362?181308				990 €	

--	--

	20"	22"	24"		
96622?010001				0 €	
96622?01000?	-			72 €	
96622?010009				154 €	
96622?010021	-	-		154 €	
966224010013	-	-		72 €	
96622?011008	-	-		72 €	
966224010007	-	-		72 €	

85512?10200?				0 €	
85512?102008				202 €	
85502?103009	-	-		186 €	
85552?000009				524 €	
8554202?0601				328 €	

85712?102009				186 €	
--------------	--	--	--	--------------	--

85712?102117 339 €					
85712?102109 339 €					
85712?102115 339 €					
85712?102116 339 €					
85712?102111 339 €					
85712?102114 339 €					
85712?102110 339 €					
85712?102112 339 €					
85712?102113 339 €					
85712?102118 339 €					

--	--	--	--	--	--

--	--	--	--	--	--

000000001104 110 €		EN ISO 14971
P.4		
P.5		
P.6		
P.7		
P.8		
P.9		
P.10		
P.11		
P.12		
P.13		
P.14		

